

Growth Hormone (GH), GH antagonists, and GH receptor “knockouts”; of mice & men (and women)

Date/Time: Wed. Feb 18th, 2004

John J. Kopchick, Ph.D.

Objectives

- Growth Hormone activities
- Growth Hormone deficiency and insensitivity in children
- Historical view of GH in terms of structure/function studies
- Discovery of a GH antagonist
- Clinical uses of a GH antagonist

Combination of clinical aspects of GH and GH activities and some basic science!!

Growth Hormone's Biological Activities

- Growth
- Lactation
- Metabolism
- Differentiation

Tissues Affected

Bone

Fat

Muscle

Liver

Kidney

Heart

Pancreas

Spleen

Intestine

And others!?

Growth Hormone - Proven Scientific Information on GH

Direct from the Internet!!!

- 8.8% muscle mass increase without increased exercise
- 14.4% decrease in fat without change in diet or habits

→ • Enhanced sexual performance

• Increased cardiac output

• Better kidney function

• Increased HDL, with a decrease in LDL cholesterol

• Faster wound healing

→ • Hair re-growth

• Mood elevation

• Improve sleep

→ • Enhances activities of all other hormones

• Improves diet

• Regeneration in growth of heart, liver, kidney

• Increase in immune functions

• Increase in exercise performance

• Decrease in blood pressure

• Develops stronger bones

• Younger and thicker skin

• Removes wrinkles ←

→ • Increase memory retention

• Decrease in hot flashes for women

The anterior pituitary gland

“The Pituitary Gland”, Armour Laboratories, 1942

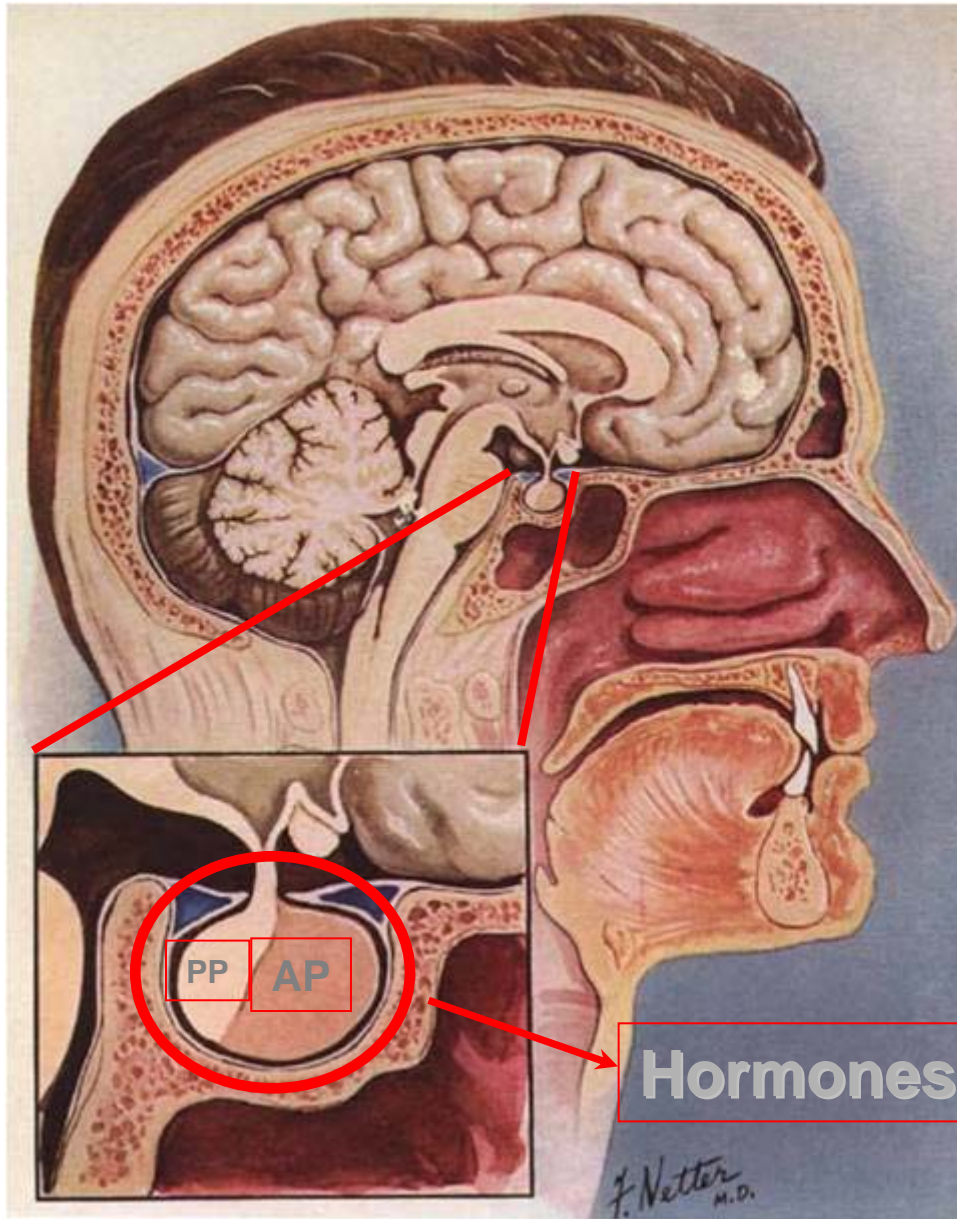

- Growth

- Metabolism

- Reproduction

- Lactation

George Auger - 8'1"
350 lbs, 24 yrs



Caroline Hass - 33"
35 lbs, 26 yrs



Ernest Rommel - 34"
45 lbs, 20 yrs

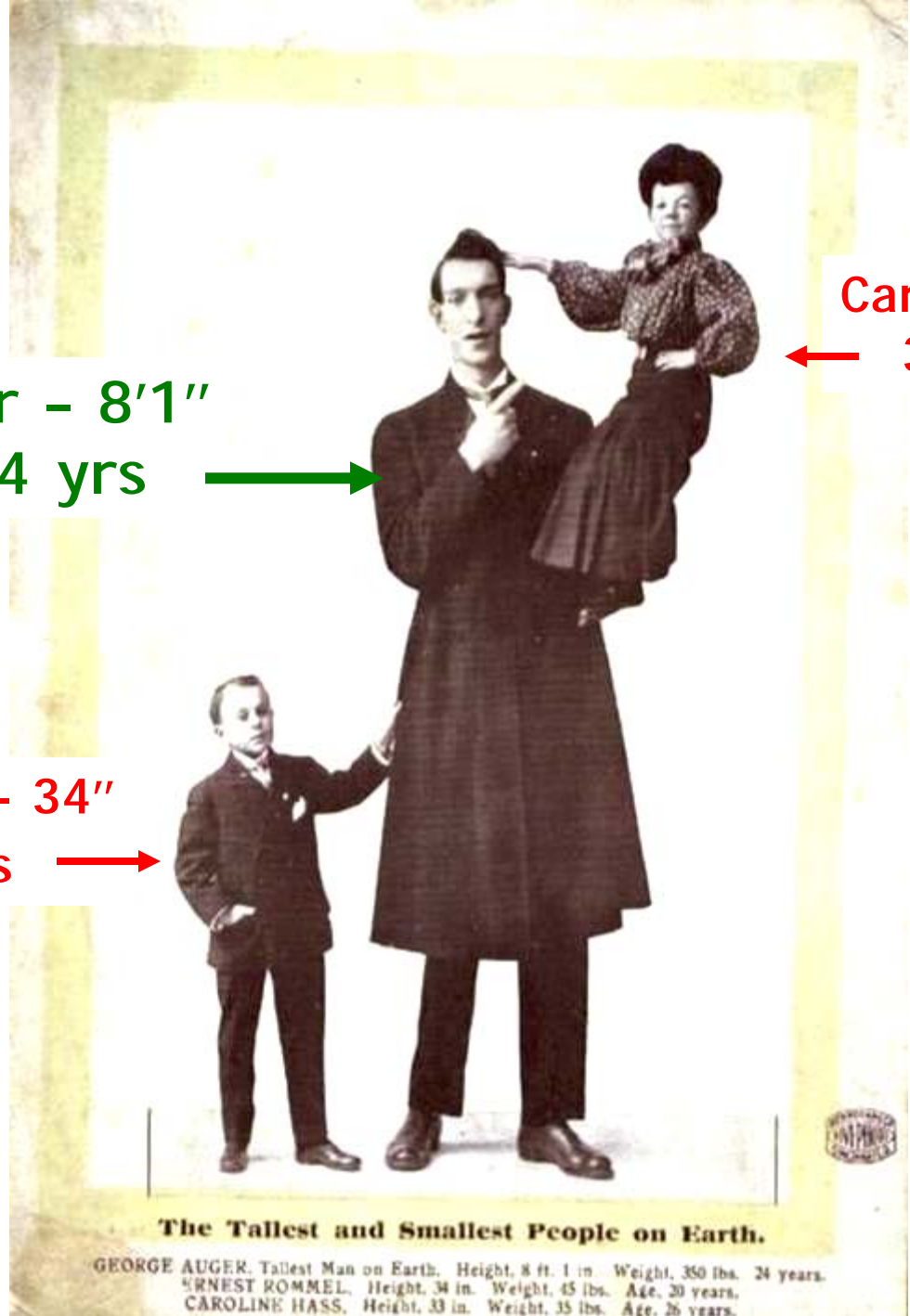

The Tallest and Smallest People on Earth.

GEORGE AUGER. Tallest Man on Earth. Height, 8 ft. 1 in. Weight, 350 lbs. 24 years.
ERNEST ROMMEL. Height, 34 in. Weight, 45 lbs. Age, 20 years.
CAROLINE HASS. Height, 33 in. Weight, 35 lbs. Age, 26 years.





© Telegraph



Robert Wadlow, 1918-1940 2.72 m.





Andre Rene Roussinoff, Andre the Giant (1947 - 1993)

Definitions

- Somatotropin - Growth Hormone (GH)
- Somatostatin - Inhibitor of GH release
- Somatomedin - Insulin Like Growth Factor I ; (IGF-1)

Control of GH Secretion

Growth Hormone Releasing Hormone

Stress, Sleep, Exercise

Hypothalamus

Somatostatin

GHRH

Anterior Pituitary

Somatostatin

GH

Somatotropin

Circulation

GH

Time

Target Tissues

Liver

Muscle

Adipose

Bone

Insulin Like Growth Factor - I

IGF-1

Somatomedin

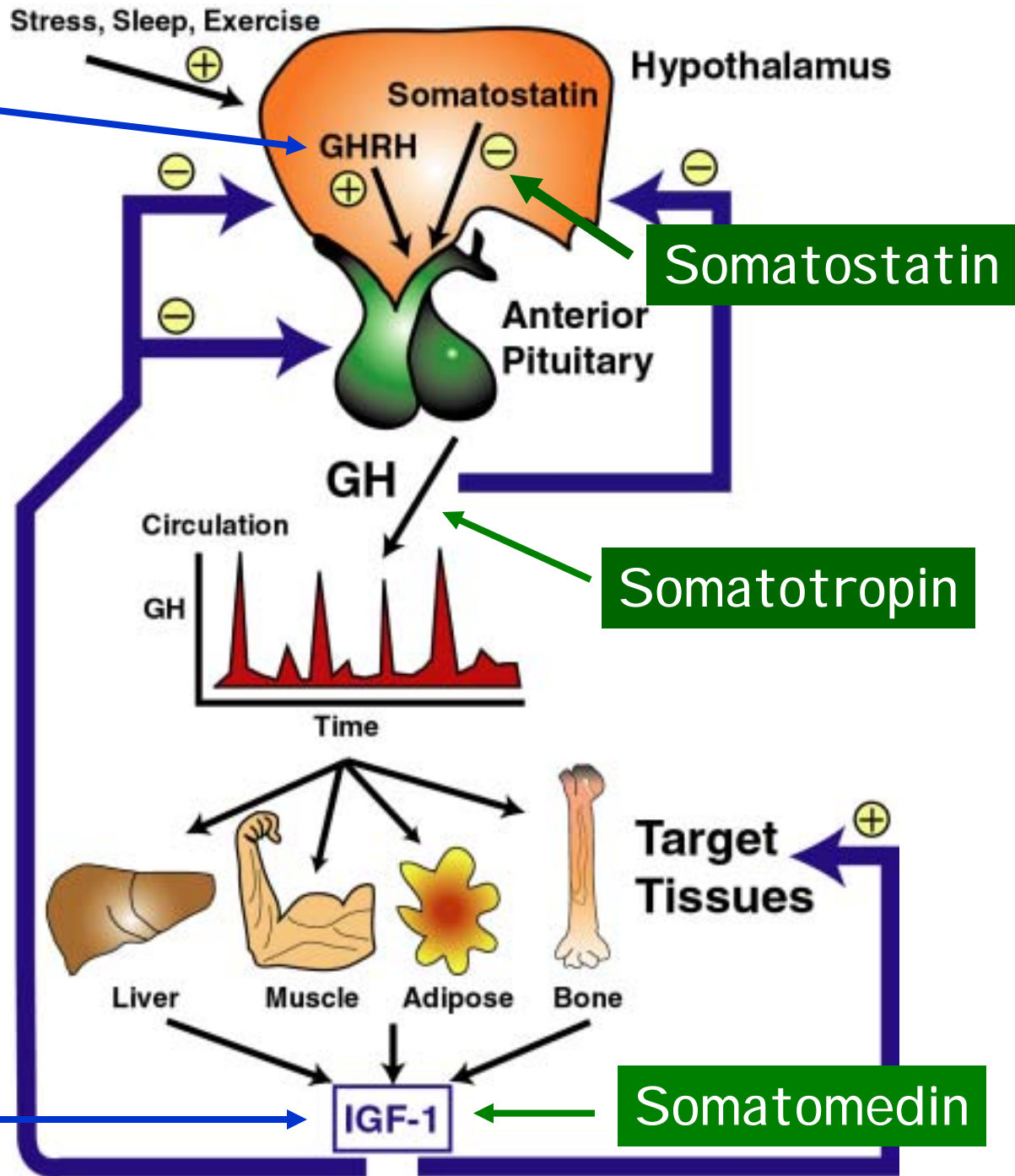

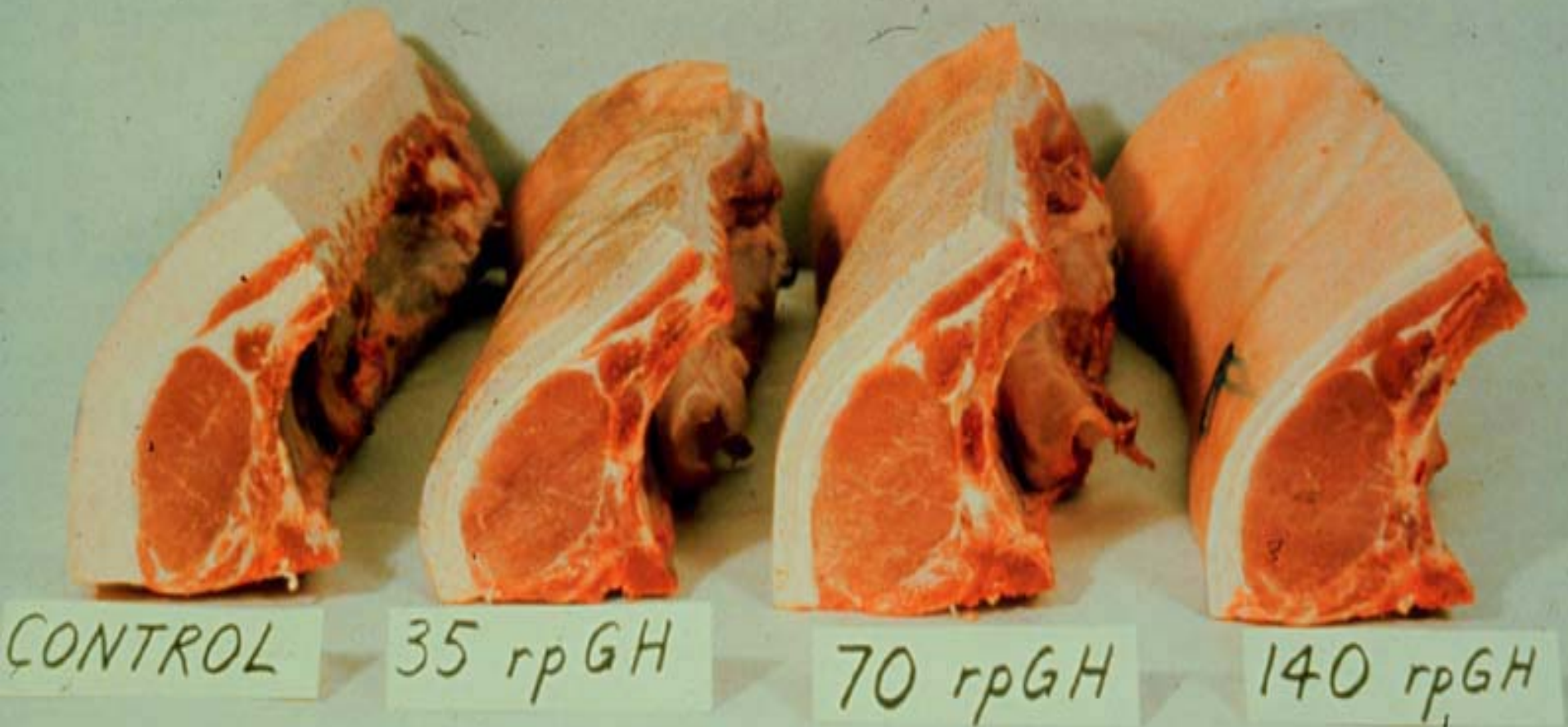

Dose dependent **decrease** in fat and **increase** in muscle and bone!!!

GH Mis-Use or Abuse

- **Less Fat, More Muscle**
- **Estimated that up to 50% of athletes at the Sydney Olympics mis-used Growth Hormone**
 - **Hard to detect (half-life 20-30 minutes)**
 - **Identical to authentic, "natural" GH**



Taking Measure Of Our Bodies . . .

The federal government may approve the use of growth hormones for children who are healthy but fall in the very lowest percentiles in terms of height. A child in the 5th percentile, for example, is as tall as or taller than only 5 percent of children at the same age (see chart).

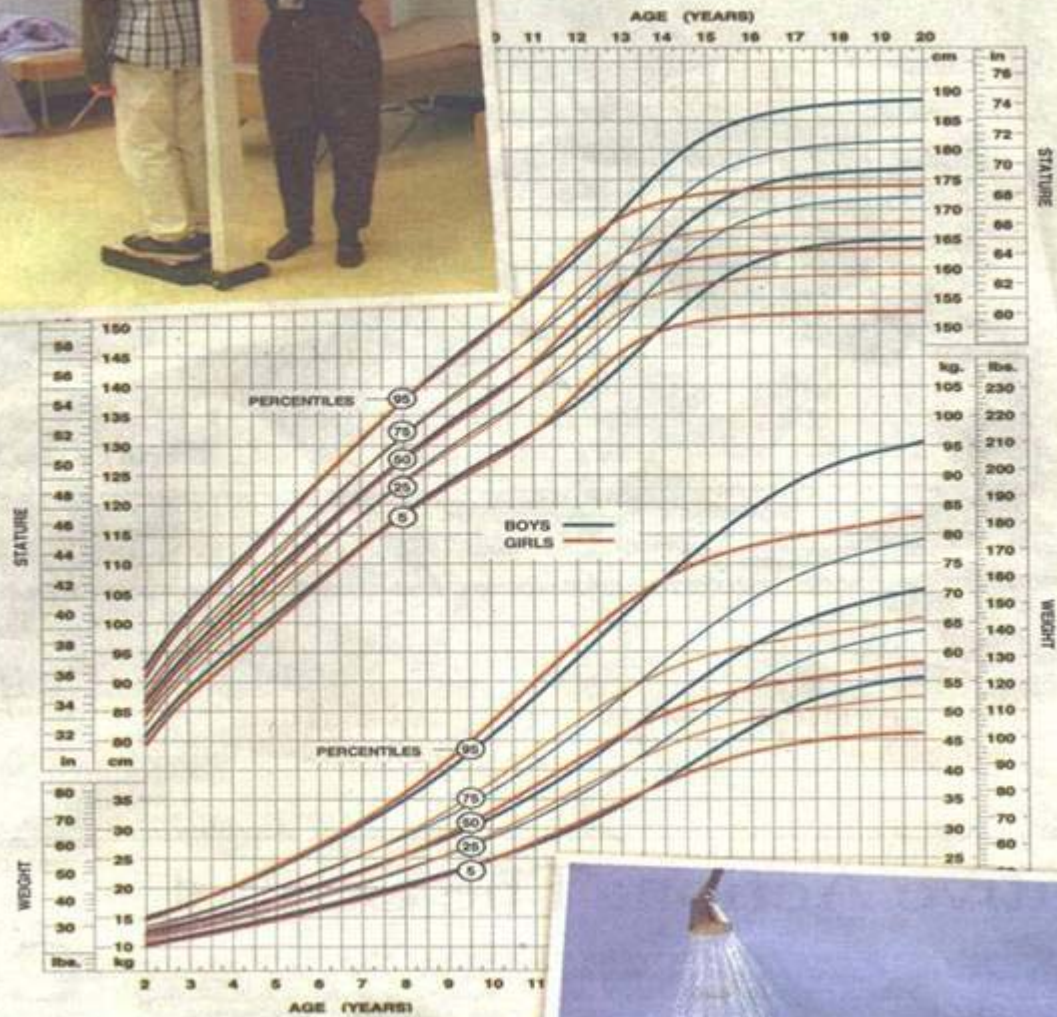

NY Times;
June 22,
2003

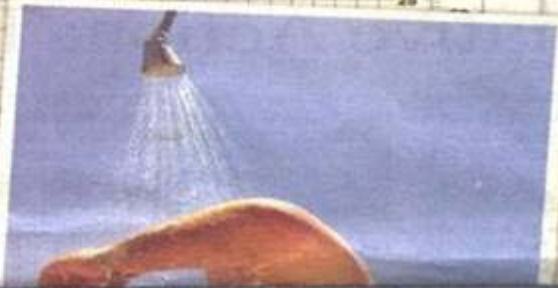

Growth Deficiency in Children

Hypothalamus or Pituitary lesions

Pituitary GH Deficiency

GH Insensitivity

IGF-1 Deficiency

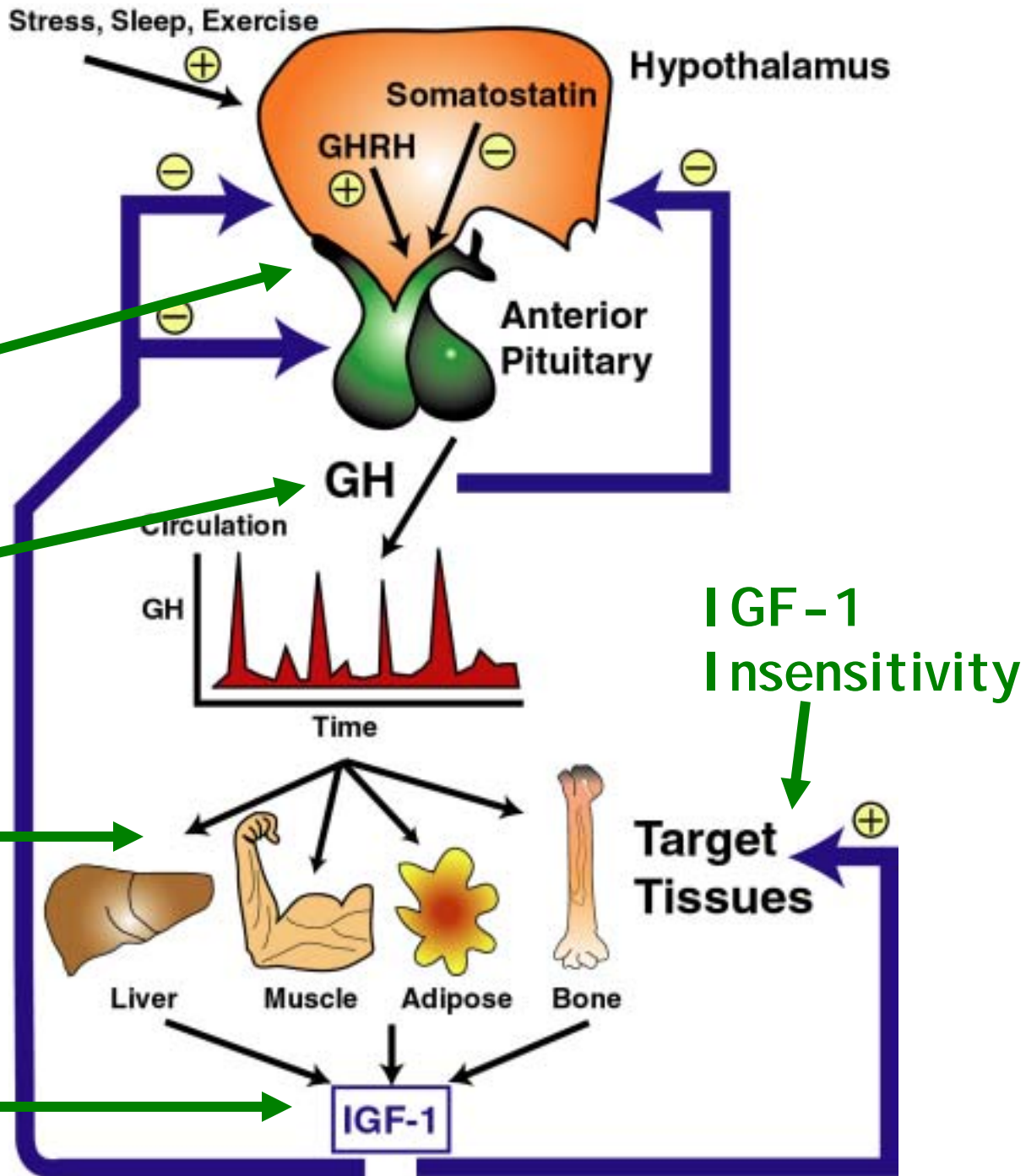

Treatment of GH Deficiency

- Historically – pituitary derived GH (discontinued in early 1985; Creutzfeldt-Jakob disease)
- Now – and since Nov., 1985 recombinant human GH (hGH)
 - Unlimited supply
 - No contamination problems

Would GH treatment “work” for individuals who are GH Insensitive?

Growth hormone deficiency, GHD, is a pituitary disorder resulting in short stature and other physical ailments. GHD occurs when the production of growth hormone, secreted by the pituitary gland, is disrupted. Since growth hormone plays a critical role in stimulating body growth and development, and is involved in the production of muscle protein and in the breakdown of fats, a decrease in the hormone affects numerous body processes.

NUTROPIN Depot, Genentech, [somatropin (rDNA origin) for injectable suspension] Growth hormone
For growth hormone deficiency (GHD) in children

GENOTROPIN®, **Pharmacia**, Lyophilized Powder (SOMATROPIN [rDNA origin] for injection) is indicated for the long-term treatment of **pediatric patients** who have growth failure due to an inadequate secretion of endogenous growth hormone. Other causes of short stature should be excluded.



In 1999, **NOVO NORDISKA/S** launched the world's first liquid hGH in a superior pen. NordiPen®, NordiPenMate®, and NovoFine® needles comprise the full **Norditropin®** SimpleXx™ delivery system. NordiPen® is a new and safe durable injection pen for injecting pre-mixed, liquid hGH from a cartridge.

Growth Hormone Deficiency (GHD):

Growth Hormone Deficiency is a condition caused by a deficiency in the normal production of growth hormone. Without treatment, a boy with Growth Hormone Deficiency would, for example, reach a height of approximately 130-140 cm at the age of 18, compared with a normal height of 182 cm. If treatment with human Growth Hormone is initiated at an early stage, a final height within the normal range of the population can be obtained.

Turner Syndrome:

Turner Syndrome is a genetic defect associated with short stature. Turner Syndrome affects girls only. It is caused by a defect of one of the X chromosomes. Treatment with human Growth Hormone, either alone or combined with an anabolic steroid, e.g. oxandrolone, can improve final adult height.

Achondroplasia:

Achondroplasia is a bone disease caused by a chromosome disorder which affects the long (limb) bones. Abnormal body proportions are apparent at birth and persist into adulthood. In addition, children with achondroplasia are often obese, and have large heads with a flattened nose. Treatment with human Growth Hormone may improve the annual growth rate in children with achondroplasia.

Chronic Renal Disease (CRD):

Growth retardation is often seen as a clinical manifestation of progressive Chronic Renal Disease in children. Since dialysis and transplantation sustain the lives of more and more children with end-stage renal failure, short stature has become a prominent problem.

Intra Uterine Growth Retardation (IUGR):

Children who are born smaller than expected are diagnosed with Intra Uterine Growth Retardation. The growth retardation may be caused by factors relating to the foetus, the placenta, the mother, or the environment.

Although most children born smaller than expected do achieve normal height within the first two to three years of their life, some children stay small throughout life. The children who do not achieve normal height may benefit from human Growth Hormone therapy. Starting treatment at the earliest age possible is very important as it has a major effect on the height gain achieved.

Prader-Willi:

Children with Prader-Willi are born with a dysfunction of a part of the brain (the hypothalamus) that controls growth, pubertal development, and feelings of hunger. As a result growth failure occurs, accompanied by an uncontrolled urge to eat continuously.

Growth Hormone Insensitivity

- Laron Syndrome

Growth Deficiency in Children

Hypothalamus or Pituitary lesions

Pituitary GH Deficiency

GH Insensitivity
Laron Syndrome

IGF-1 Deficiency

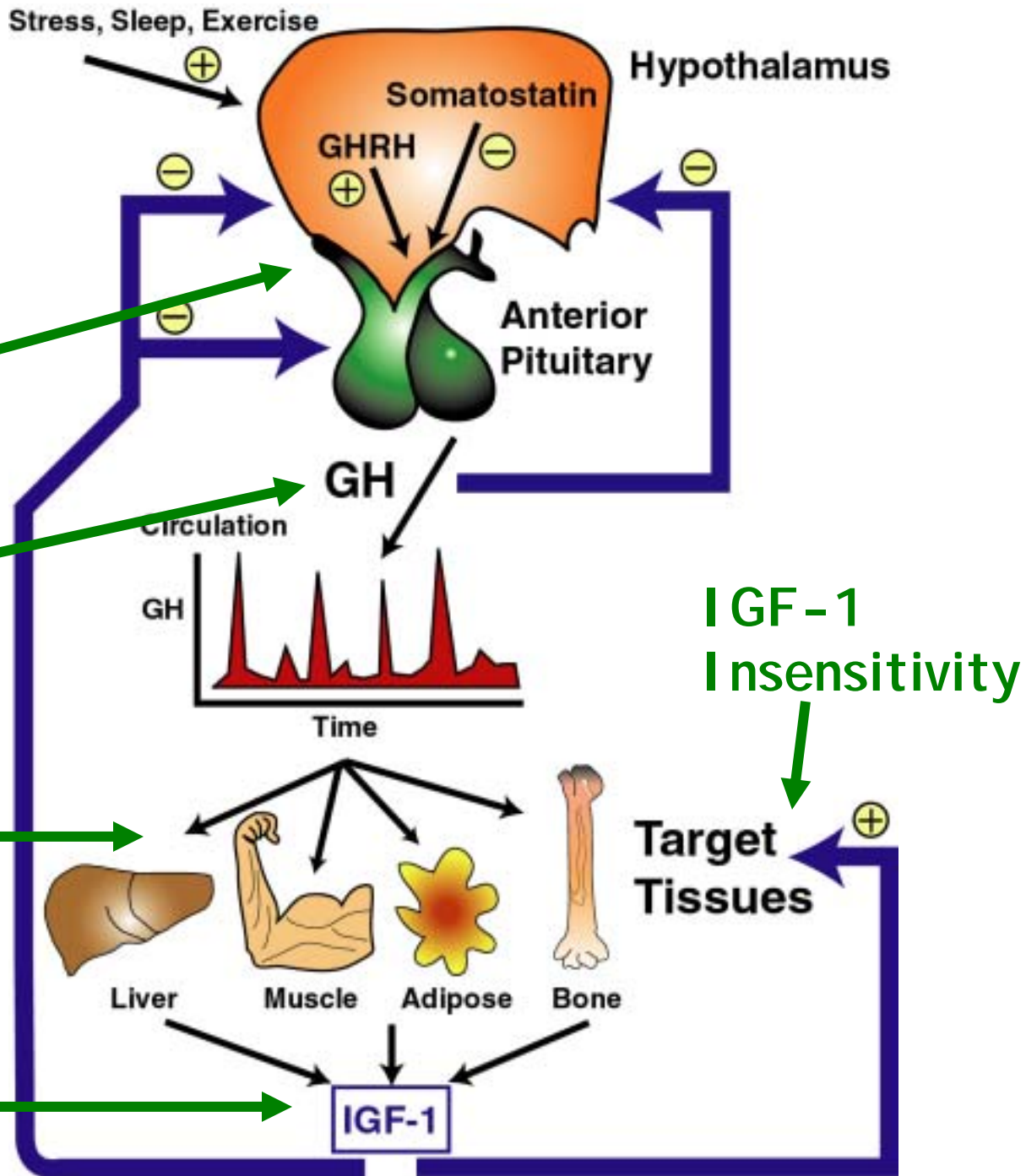

GHR

GHBP

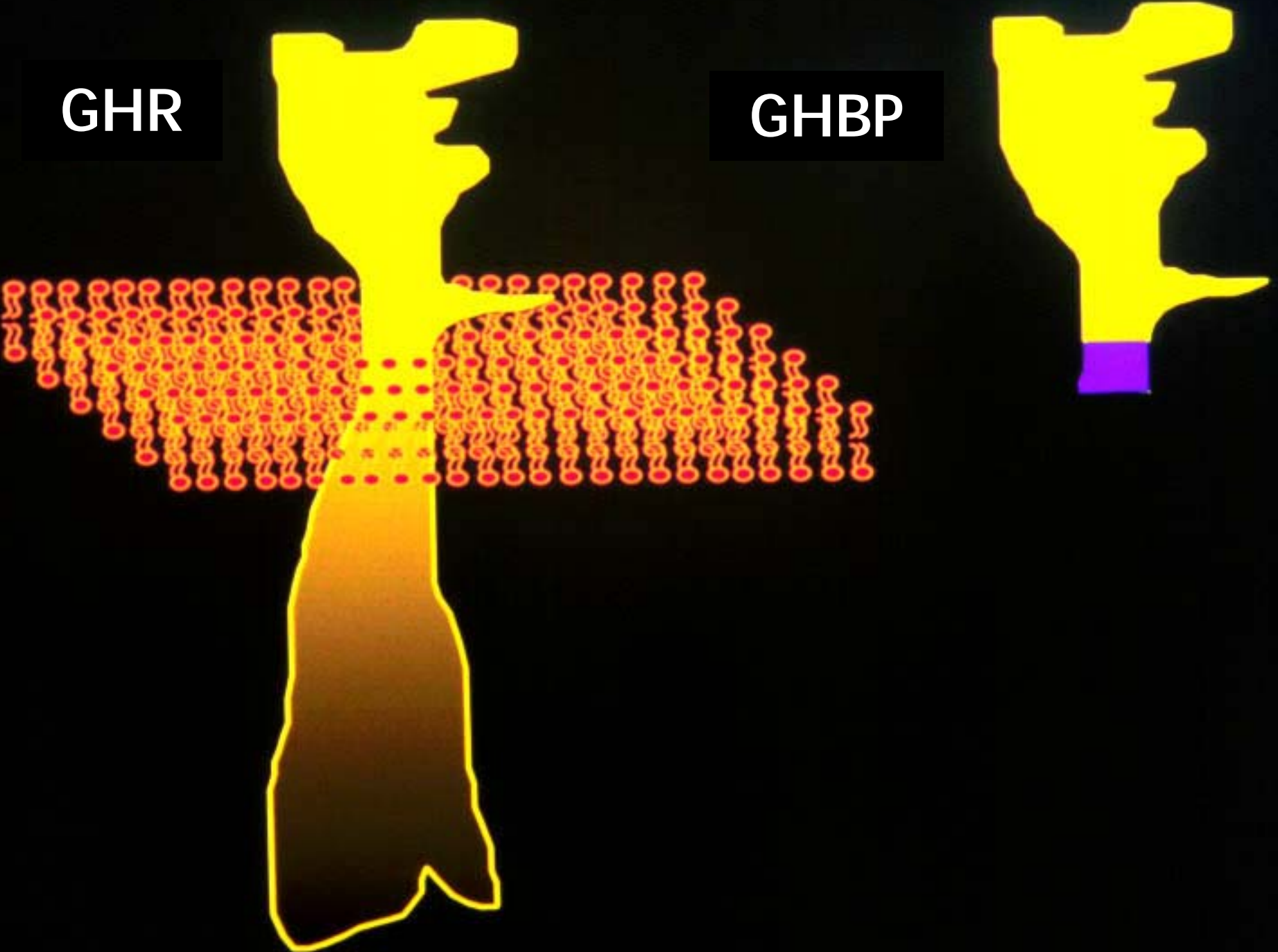



Typical facial appearance of a 5 yr old boy with LS due to a molecular defect of the GHR. Note the sparse hair, protruding forehead, saddle nose, and small chin.

JCEM, 1999, 84:4397

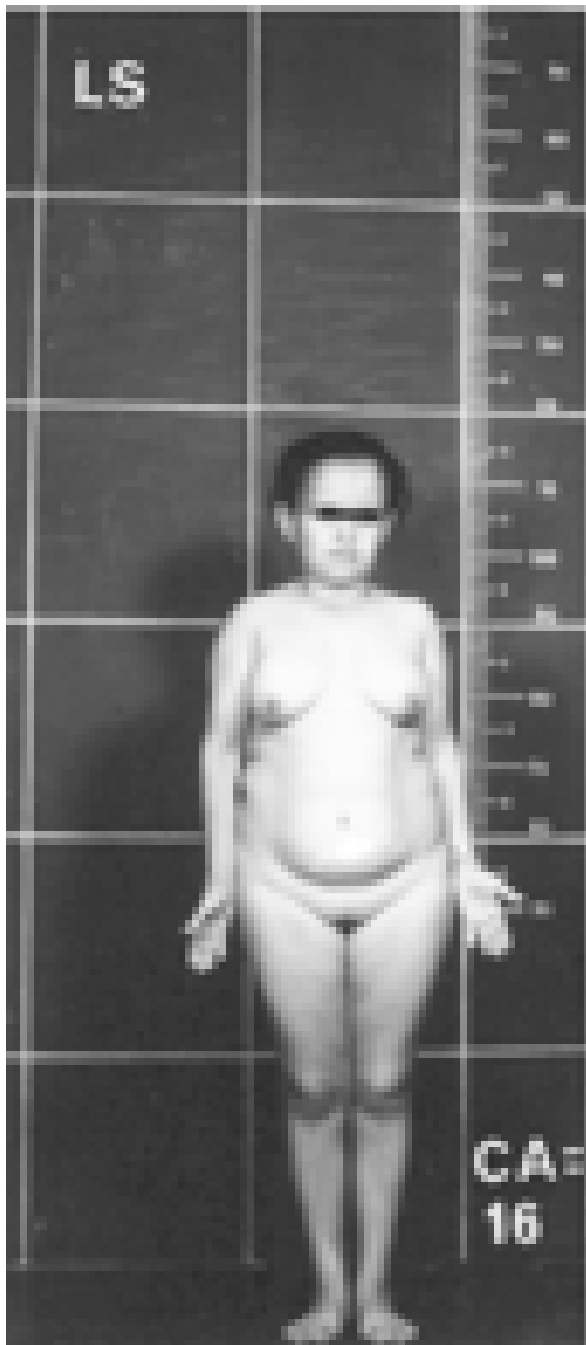

Height of a 15 year old girl with LS (left) as compared with a 15 year old healthy girl (right)

JCEM, 1999, 84:4397

GHR

GHBP

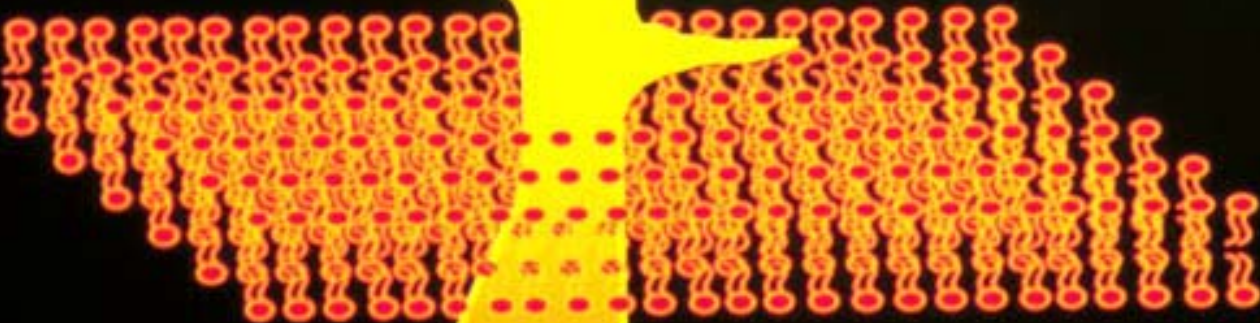

The image shows three mice from a back view against a yellow background. The mice decrease in size from left to right. A yellow box with the text 'The Laron Mouse' and an arrow points from the middle mouse to the smallest mouse on the right. Below each mouse is a genotype label: '+/+', '+/-', and '-/-'.

The Laron Mouse →

+ / +

+ / -

- / -

GHR/BP gene disrupted mice

Growth Hormone and Aging

“New Stuff”

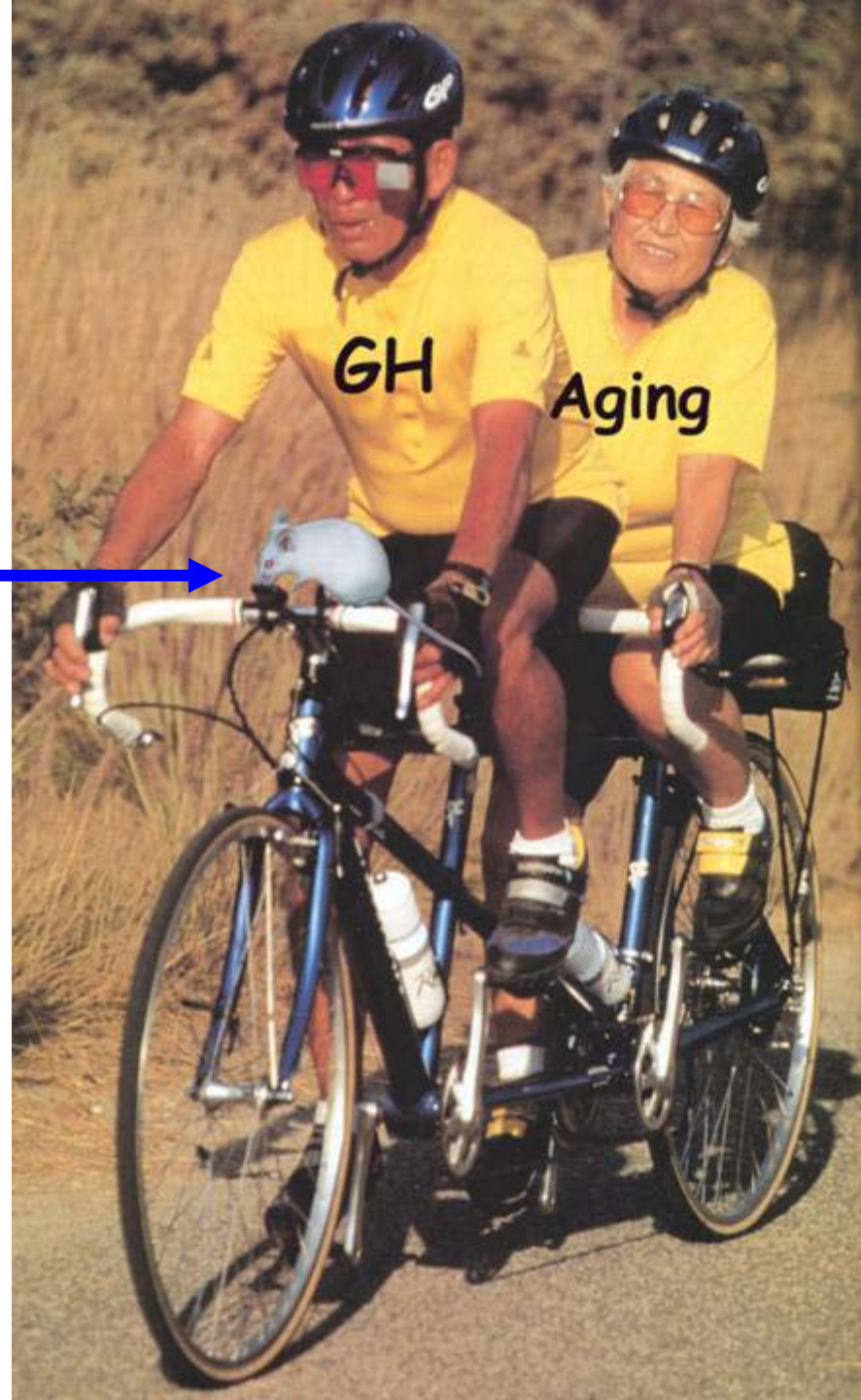

st

"GH and aging" on the "net"

Web Pages

6 - 20 of 65891



Growth hormone sales, hgh muscle.

<http://www.romanticmall.com/~natural/growth/Growth-hormone-sales.html>
Ultimate HGH is your answer. It contains the nutrients needed to support the natural release of HGH, your key to adding years of vitality on to your life. The combination of Glutamine Peptides and Colostrum give Ultimate HGH a remarkable edge in rev

Human growth hormone sale, antiaging clinic longevity.

<http://www.romanticmall.com/~sales/hgh/human-growth-hormone-sale.html>
Ultimate HGH contains other all natural ingredients to give your body the energy and improvement you desire most. ...human growth hormone sale

Enjoy A New Youth With Powerful PRO-hGH Tablets gh growth hormone

http://fountainsofyouth.o8.net/ALTERNATIVE_MEDICINE
gh growth hormone at Age Reversal Centers gh growth hormone

Enjoy A New Youth With Powerful PRO-hGH Tablets (human growth hormone stimulator increase cardiac output)

<http://fountainsofyouth.o8.net/Fountainofyouth>
human growth hormone stimulator - human growth hormone stimulator at Age Reversal Centers

human growth hormone stimulator

[http://fountainsofyouth.o8.net/AGEREVERSALHUMANGROWTHHORMONE.h](http://fountainsofyouth.o8.net/AGEREVERSALHUMANGROWTHHORMONE.htm)
[tm](http://fountainsofyouth.o8.net/AGEREVERSALHUMANGROWTHHORMONE.htm)human growth hormone stimulator at Age Reversal Centers human growth hormone stimulator

Experts in the *New England Journal of Medicine, Science, Newsweek, Time*, and more report...

Human Growth Hormone... Makes You Look and Feel 20 YEARS YOUNGER!

"Growing Old Is Not Inevitable"

The Scientific Evidence Is Overwhelming

The American Academy of Anti-Aging Medicine, with 5000 members, states that the body's reduced production of human growth hormone is a primary cause of aging.

Growth Hormone Decreases 75% From Age 25 to 70

From the age of 20, growth hormone levels in your body decrease by more than 75%. And you age faster. Practically EVERY man and woman over the age of 40 has a growth hormone deficiency. The evidence is overwhelming.

- You gain weight
- You lose muscle mass
- Your eyesight, sexual energy and vigor decrease
- Your hair loses luster and color
- You don't feel 20 anymore!

Growth Hormone Decline

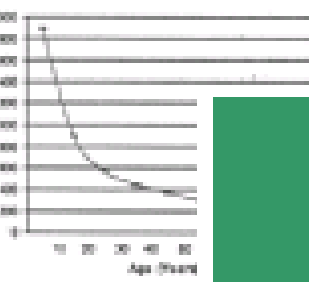

Why Is Growth Hormone So Important?

Human Growth Hormone (HGH) is one of many endocrine hormones, like estrogen, progesterone, testosterone, insulin, and cortisol, that regulate the body's metabolism.

The biggest breakthrough in anti-aging medicine at the time and led to a big announcement that, in the words of I. Rudman, "The overall deterioration of the body that comes with growing old is not inevitable."

Dr. Rudman studied men between the ages of 60 and 80 who were overweight. These men could not alter their diet, exercise, or smoking habits. When they...

American Academy of Anti-Aging Medicine: "By replenishing your levels of growth hormone...

"Youth" lies within the cells of each of us. All you need to do is release it!"

Increase Lean Body Mass...

Scientific evidence overwhelming!!
"What a baseball player says!!"

says about HGH Gold Gold:

"I played in the major leagues for 8 years and have been in professional baseball playing and coaching for over 20 years. I know what joint pain is. I have been taking HGH Gold for 2 months now and I have lost 11 pounds. My 48-year-old body is free from pain. Before taking HGH Gold I had joint pain in my right elbow and...

six months to a younger you!!

Not \$175/bottle but yours for only \$49.95

expert says!!

HGH GOLD

most highly researched safe and effective Growth Hormone enhancing nutrients - including Arginine, Lysine, Glutamine, Glycine and Triac into a simple oral spray - HGH Gold. These all natural...

100's of Americans Already Feel and Look YOUNGER

HGH Gold has been helping thou...

"metabolic make-over" to help energize you and make you feel younger each and every day - day in and day out.

HGH Gold's revolutionary spray technology allow you a painless, less expensive alternative to shots.

The advantage of every opportunity your body has to regain your youthful vitality for the rest of your life. Order your HGH Gold TODAY and SAVE.

Here's an Incredible PRICE BREAKTHROUGH!

You don't have to spend thousands of dollars on shots.

You don't have to spend the \$175 per bottle that HGH Gold is selling for in some Clinics in the United States and Europe.

For the next 30 Days, you can obtain a complete one-month supply of HGH...

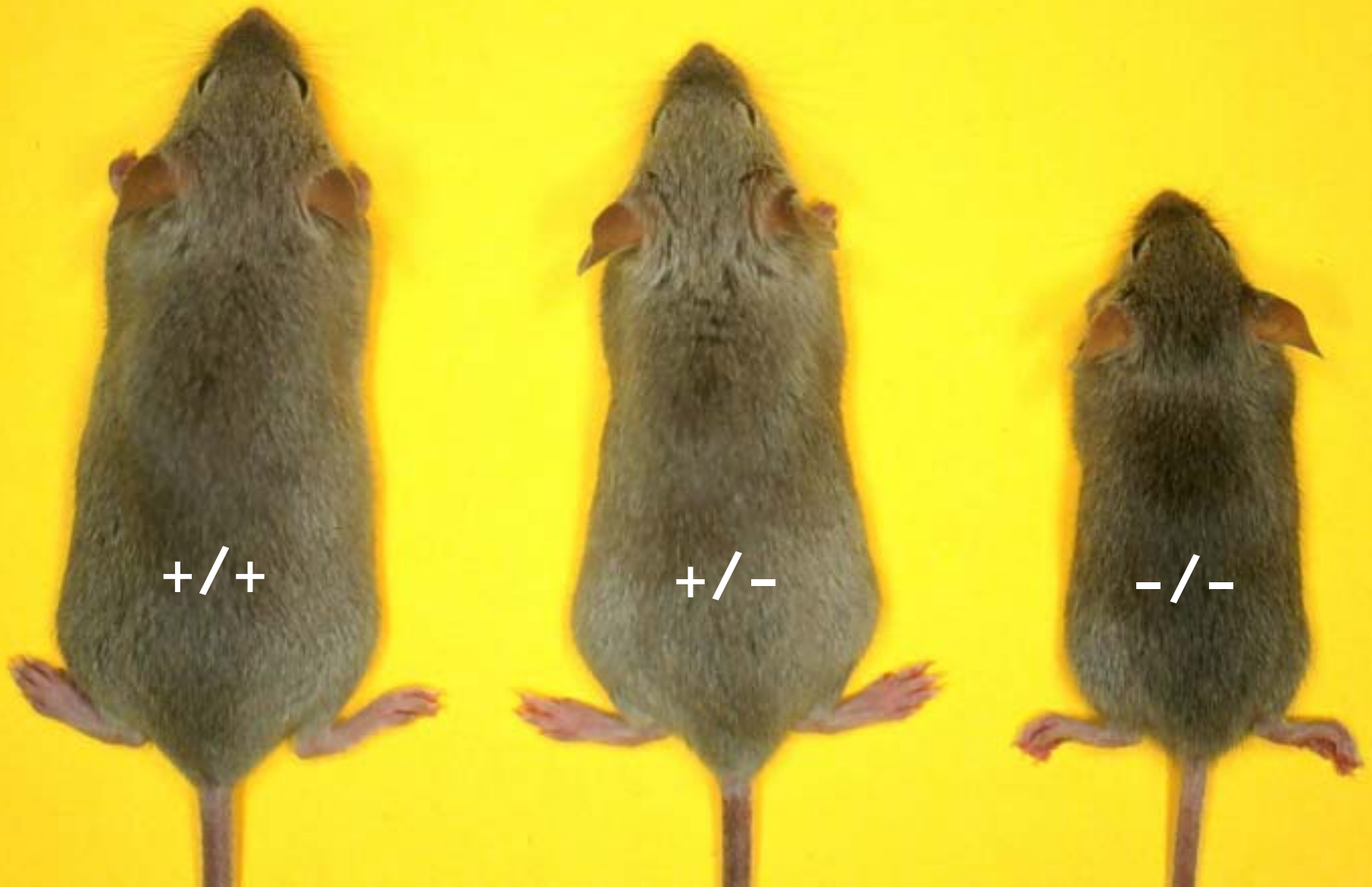

Back to the GHR/BP gene disrupted mice

Survival Curve

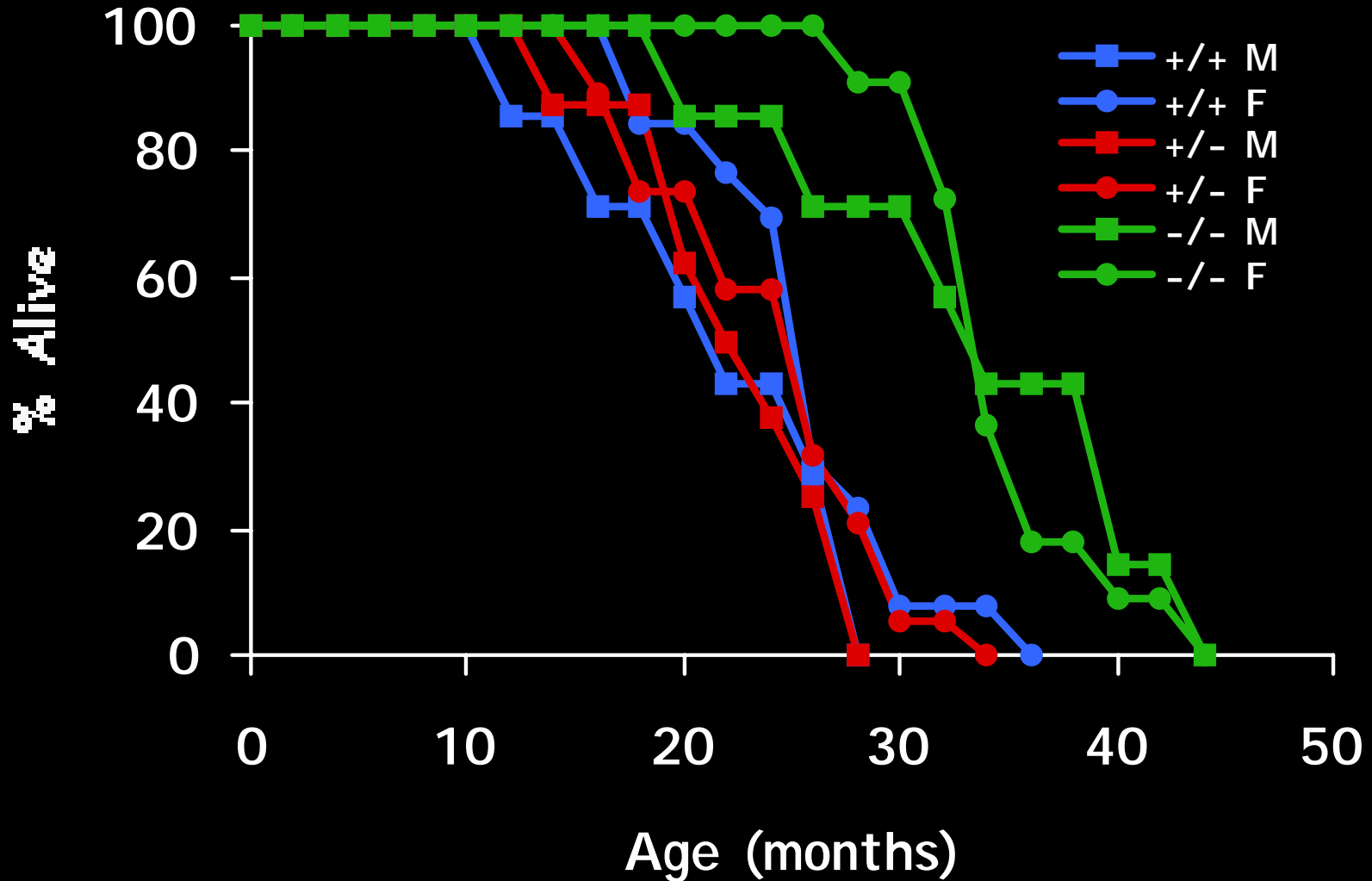

Analysis of lifespan in GHR/BP gene-disrupted mice

Gender	Genotype	N	Lifespan (days)*
Male	+/+	7	629 ± 72
	+/-	8	668 ± 51
	-/-	7	975 ± 106 ^a
Female	+/+	13	749 ± 41
	+/-	19	701 ± 36
	-/-	11	1031 ± 41 ^b



* Mean ± S.E.

^a P < 0.01 compared to +/+

^b P < 0.0002 compared to +/+

Methuselah Mouse Prize!!!!

- **Money for old mice**
- Competition seeks world's longest-lasting mouse.
Nature 22 September 2003 [HELEN R. PILCHER](#)

A contest to produce the oldest laboratory mouse, and so help to unravel the mysteries of human ageing, is launched in Britain today.

Strategies that promote long life in rodents may lengthen our lives too, enthuses **Methuselah Mouse Prize** organizer Aubrey de Grey of the University of Cambridge, UK. The competition aims to encourage research and funding for anti-ageing interventions, he says.

The **current title-holder**, affectionately known as **GHR-KO 11C**, died just a week short of his fifth birthday - the equivalent of a human living for 150 years.



Does GH promote aging or decrease longevity??

- Very controversial!!!!
- More to follow!!!!

Is GH administration to the elderly a "quality of life" Issue???

The "Little People" of the Island of Krk - Revisited. Etiology of Hypopituitarism Revealed

Ciril Kržišnik¹, Zdravka Kolacio², Tadej Battelino¹, Milton Brown³, John S. Parks³ and Zvi Laron⁴

¹*Department of Pediatrics, University of Ljubljana, Slovenia*

²*Department of Medicine, University of Rijeka, Croatia*

³*Department of Pediatrics, Emory University School of Medicine, Atlanta, GA, USA*

⁴*Endocrinology and Diabetes Research Unit, Schneider Children's Medical Center and Sackler School of Medicine, Tel Aviv University, Israel*

ABSTRACT

Hereditary dwarfism was first recognized in inhabitants of the island of Krk in the Adriatic in 1864. Since then 24 related dwarfs have been recorded. Their pedigrees and heights are presented. Ten of these patients live in the villages Bašćanska Draga and Jurandvor. Six have been studied by the authors. Clinical examination revealed dwarfism, obesity, dry wrinkled skin, and lack of sexual development. Hormonal investigations showed the absence of growth hormone (GH) unresponsive to growth hormone releasing hormone (GHRH), absence of luteinizing hormone (LH) and follicle stimulating hormone (FSH) unresponsive to gonadotropin releasing hormone (GnRH), and absence of thyrotropin stimulating hormone (TSH) unresponsive to TRH. Basal serum prolactin (PRL) was low but secretion of ACTH was normal as evidenced by normal cortisol levels. Hypopituitarism in this isolate was not associated with a shortened life span or an increased incidence of diabetes. PROP-1 is a pituitary specific transcription factor that is required for the embryologic development of the pituitary cell types that ultimately produce GH, PRL, TSH and FSH/LH postnatally. Examination of genomic DNA from

results in a premature translational stop signal at codon 164. The truncated protein lacks the DNA-binding and transcriptional activation domains.

In conclusion, basic insights into the transcription factors contributing to pituitary development led to definition of hereditary multiple pituitary hormone deficiency (MPHD) dwarfism on the island of Krk. The hypopituitarism is due to a mutation in the PROP-1 gene. This genetic isolate provides a unique opportunity to characterize the long-term effects of hypopituitarism caused by PROP-1 deficiency.

KEY WORDS

hereditary dwarfism, panhypopituitarism, PROP-1, island Krk

INTRODUCTION AND HISTORY

Hereditary dwarfism on the island of Krk in the North Eastern part of the Adriatic Sea (Fig. 1) was first recorded in the 19th century. The affected individuals originated from two closely located villages: Bašćanska Draga and Jurandvor. They were called "Mali ljudi" (short people) by the

clinical features of affected individuals in family 1 of the Wu *et al.* report¹⁰ and a second sibship with the same R120C missense mutation of PROP-1 were presented in greater detail in a later report¹⁴. The three males and two females in these families each showed signs of spontaneous puberty and the females experienced menarche at ages 14 and 16. Progressive loss of LH and FSH responses to GnRH between ages 15 and 30 was documented in three of the patients. We suspect that the youngest patient in our series underwent a similar transition from partial to complete gonadotropin deficiency. The patients described by Fluck *et al.*¹⁴ had a missense mutation which leads to a protein that retains roughly 12% of DNA-binding and transcriptional activation activities¹⁰. Our patients from Krk had a gene abnormality that would be expected to result in total loss of PROP-1 function. Thus, the emergence of signs of pubertal development is not limited to persons with partial loss of function mutations. Variability in this regard may reflect differences in genetic background rather than the precise nature of the PROP-1 mutation.

It is of note that despite the long-term thyroid hormone deficiency, these patients seem to get along in everyday life. Nevertheless, the coarse and wrinkled skin as well as lack of adequate schooling and various degrees of intellectual deficiency are consistent with long-term TSH and IGF-I deficiencies¹⁸. Of note is lack of diabetes as reported in long-standing GH deficiency¹⁹. The hypercholesterolemia typical of both hypothyroidism and GH deficiency²⁰ does not seem to have caused evident heart disease, but echocardiography was not performed.

It is further of note that despite the long-standing MPPHD, these patients reached very old ages. Patients b-3 to b-6 survived to ages 83, 91, 77 and 68 respectively, as compared to the average life expectancy of 70.2 years for males and 77.0 years for females in Croatia²¹. This is in contrast to the findings by Rosen and Bengtsson²² who reported a shorter life span for patients with hypopituitarism acquired in adulthood. The difference in findings may be due to the fact that most of Rosen's patients lacked ACTH and the Krk patients did not. Although the Krk patients showed premature wrinkling of the skin, they had little or no gray hair.

There is evidence from the Snell and Ames mouse models that MPPHD may actually result in a prolongation of life-span²³. The initial study of the Snell mouse, now known to have a missense mutation in the POU1F1 gene²⁴, showed decreased longevity and this was attributed to immunodeficiency²⁵. Later studies have not confirmed this finding but have shown increased longevity²³. The effect of the Ames mutation on longevity is quite dramatic. Dwarfs outlived their litter-mates by about a year, with the average age at death being 723 and 718 days in normal males and females and 1076 and 1206 days in dwarfed male and female mice²⁶. It is not clear whether prolongation of life-span is due to GH, PRL or TSH deficiency or to a combination of anterior pituitary hormone deficiencies. Validation of the effect of pituitary hormone deficiency on aging in humans stands in contrast to the literature linking GH deficiency to blood lipid abnormalities associated with early appearance of atherosclerotic cardiovascular disease^{20,22}.

ACKNOWLEDGEMENTS

We thank Sharon Langley of the Division of Medical Genetics, Emory University, for assistance with sequencing. Supported by grants 97-27 and 98-7R from the Genentech Foundation for Growth and Development.

REFERENCES

1. Wagner von Jauregg J. Über marinen Kretinismus. Wiener Klin Wchschr 1906; 19: 1273-1278.
2. Hanhart E. Über hereditäre degenerativen Zwergwuchs mit Dystrophia adiposo-genitalis. Arch Klaus Stift 1925; 1: 235-253.
3. Vojska V. Beitrag zur Erforschung des Zwergwuchsproblems. Arch Rassen U Ges Biol 1940; 34: 433-469.
4. Fraser GR. Studies in isolate. J Genet Hum (Paris) 1964; 13: 32-46.
5. Zergollein LJ. A follow-up on Hanhart's dwarfs of Krk. Birth Defects Original Article Series 1971; 7: 28-32.
6. Kopajčić B, Brozović Z, Dujmović M, Lolić V. Hereditary dwarfism in the island Krk. Proceedings Third Yugoslav Endocrinological Scientific Meeting, Sarajevo, Yugoslavia 1972; 221-227 (in Croatian).
7. Jerkunica I, Kopajčić B, Novak V. First results of pituitary hormone determination in dwarfs from island of Krk. Proceedings First Yugoslav Congress Nuclear

Pertinent clinical data of the 24 known hypopituitary patients from the island Krk originating in two villages:
Baščanska Draga (a) and Jurandvor (b)

Patient No.	Sex	Year of birth	Age at height measurement		Comment	Ref. no.	Present Study
			years	cm			
Village (a) Baščanska Draga							
1	M	1864	42	106	Deceased	1	
2*	M	1869	55	117.5	Deceased	2	
3	F	1877	38	112.4	Deceased	2	
4	F	* 1927	11	114	Sibling of pt. a-5	3	
5	M	* 1930	8	110.6	Sibling of pt. a-4	3	
6	F	* 1927	45	131	Sibling of pt. a-7	6	
7	M	* 1930	42	142	Sibling of pt. a-6	6	
8	F	* 1930	58	120			X
9	M	* 1939	49	139	Sibling of pt. a-10		X
10	F	1943	47	152	Sibling of pt. a-9		X
11	F	1948	25	142		7	
12	F	1976	14	142	Irregularly treated by T ₄ and hGH		X
Village (b) Jurandvor							
1	M	1877	47	105.9	Deceased	3	
2	M	1880	44	122.1	Deceased	2	
3	M	1886	37	126	Died in 1969* at age 83 yr	2	
4	F	1890	34	133.2	Died in 1981* at age 91 yr	2	
5	M	1892	32	128.5	Died in 1969* at age 77 yr	2	
6	F	1894	30	130.2	Died in 1962* at age 68 yr	3	
7	M	1891	-	-	Deceased	2	
8	F	1894	12	115	Deceased	1	
9	M	1922	68	132			X
10	M	1930	58	135			X
11	M	* 1957	15	141		6	
12	M	* 1921			Moved to USA	6	

*Siblings

*

Small for Gestational Age (SGA)

Approximately 5% of all infants are born SGA. SGA is often, though not always, associated with intra-uterine growth retardation (IUGR).

Technically, IUGR implies a pathophysiological cause for the inhibition of normal growth *in utero*. In contrast, the etiology of SGA can not always be identified.

While many SGA neonates normalize their stature by the time they reach 2 yrs. of age, 8-10% of SGA children will not experience sufficient catch-up growth. Without treatment, these children remain short and constitute some 14-22% of adults whose height is below -2SD scores.

Definition of Small for Gestational Age (SGA)

Birth weight and/or length of 2 or more standard deviations (SD) below the mean for gestational age and sex

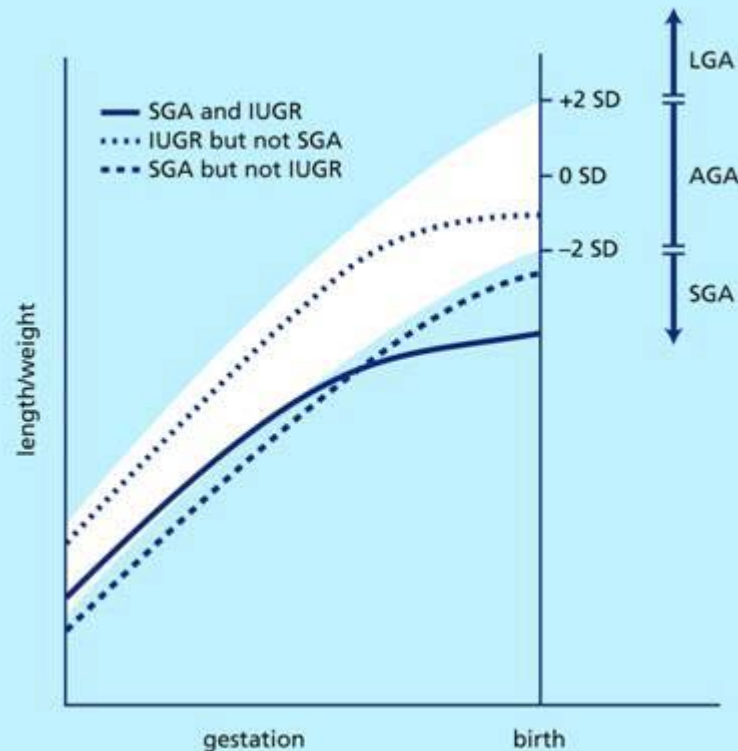

Hormonal regulation of fetal size

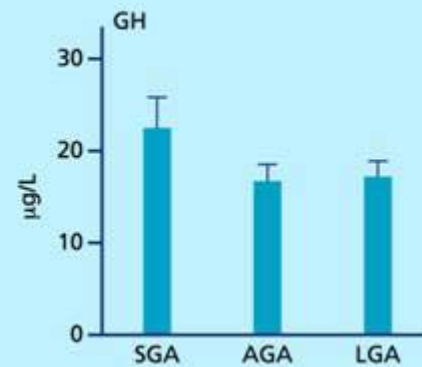
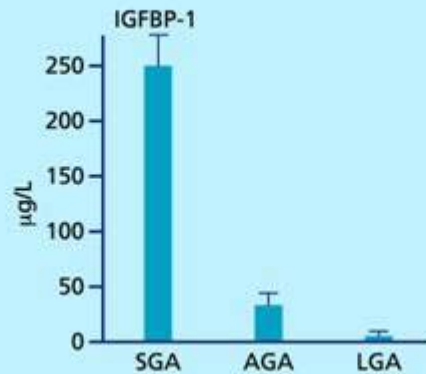
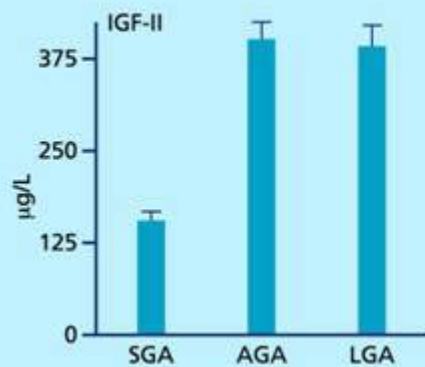
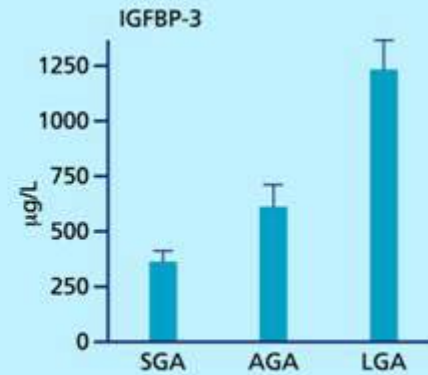
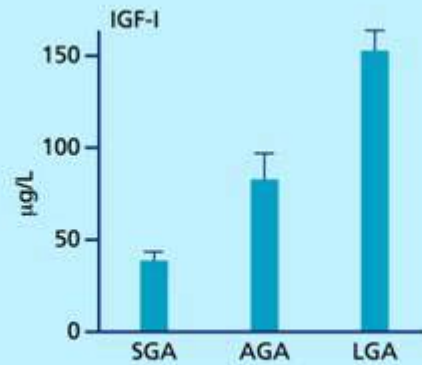
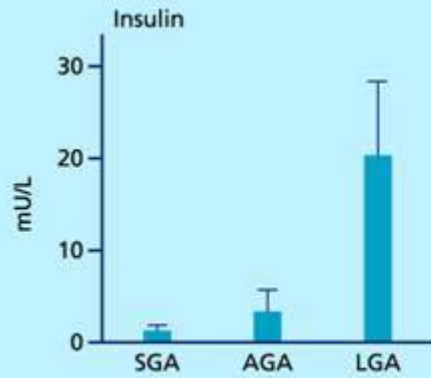

GH improves height in children born SGA

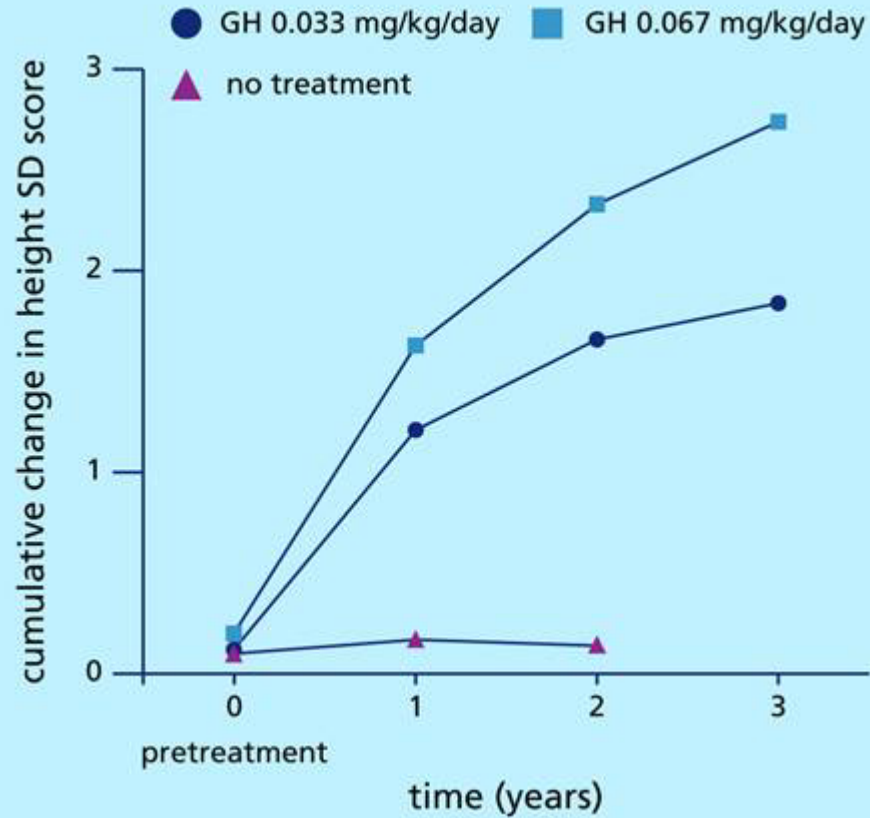

Dutch-Norditropin study: Growth response

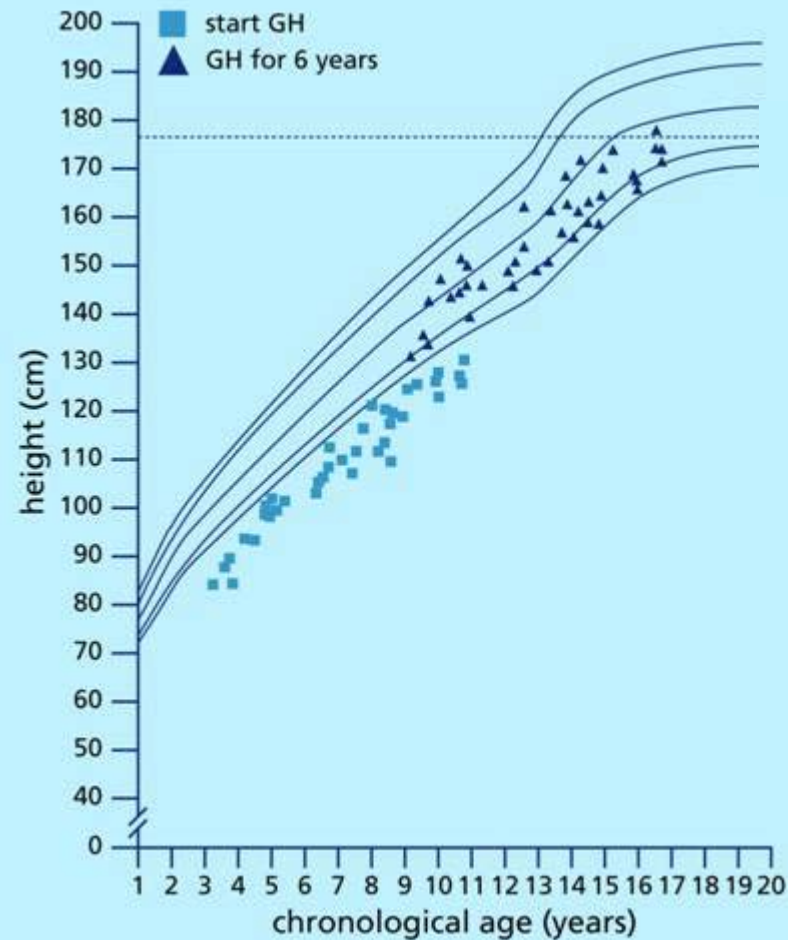

Summary

- Approximately 10% of children born SGA exhibit poor growth during childhood, which results in short adult stature
- Children born SGA who remain short may be psychosocially disadvantaged. They may also have an increased risk of metabolic and cardiovascular problems in adult life. This has so far only been shown in children born SGA who exhibit spontaneous catch-up growth.
- Disturbances in the GH-IGF-I axis may play a role in the lack of catch-up growth in these children
- GH therapy (0.033 or 0.067 mg/kg/day) induces a dose-dependent acceleration of growth during the first 3–4 years of treatment
- GH therapy improves self-confidence and peer acceptance in short children born SGA
- GH is safe and well tolerated in short children born SGA

How does GH transmit cellular signals?

- GH is secreted by the pituitary gland and enters the circulatory system, thus, it is a classic endocrine hormone
- GH binds to GH receptors (R) on target tissue

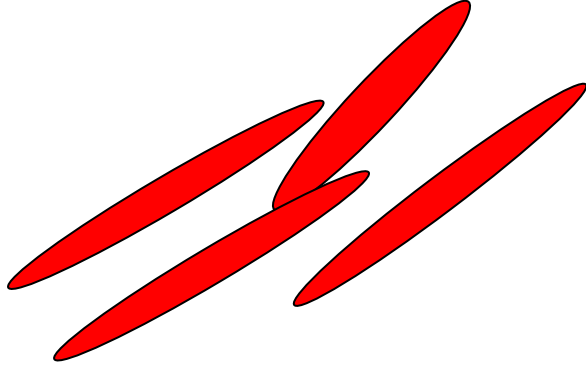

GH

**Pre-formed
GHR Dimer**

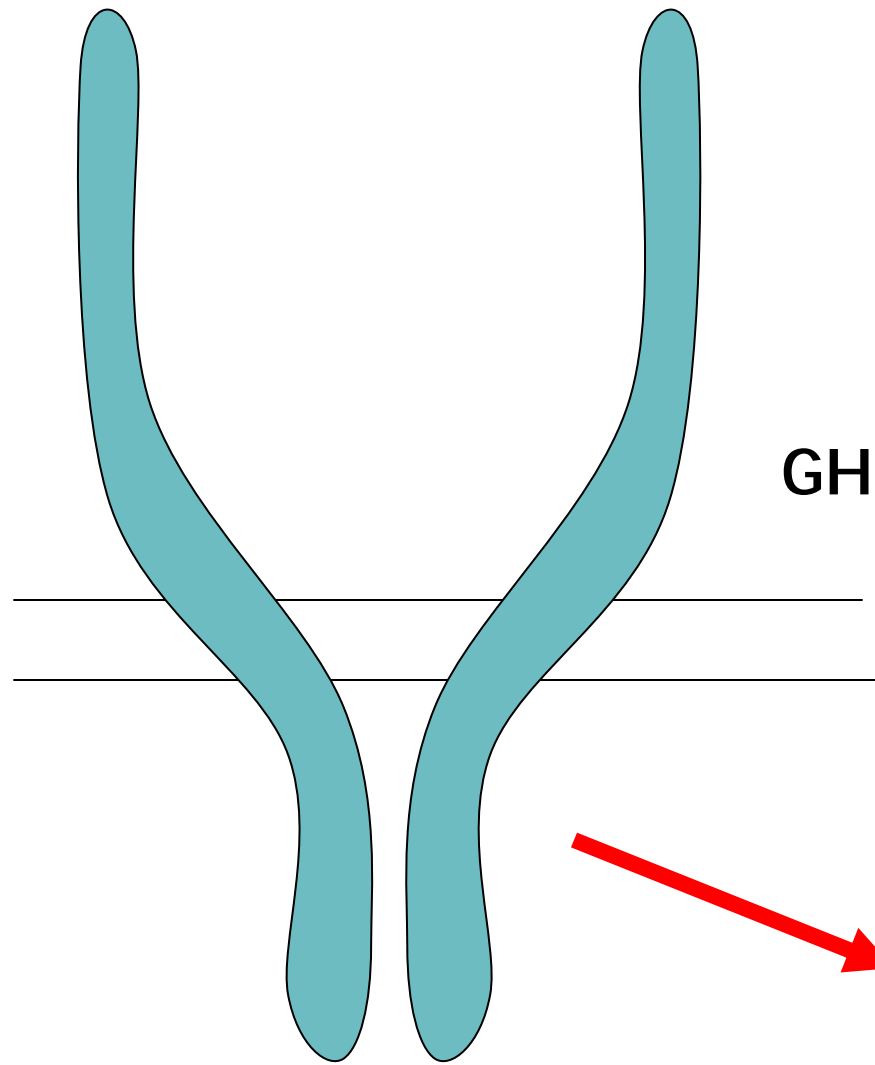

**Proper or
Functional
GHR Dimerization**

**Signal
Transduction**

GH | **GHBP**

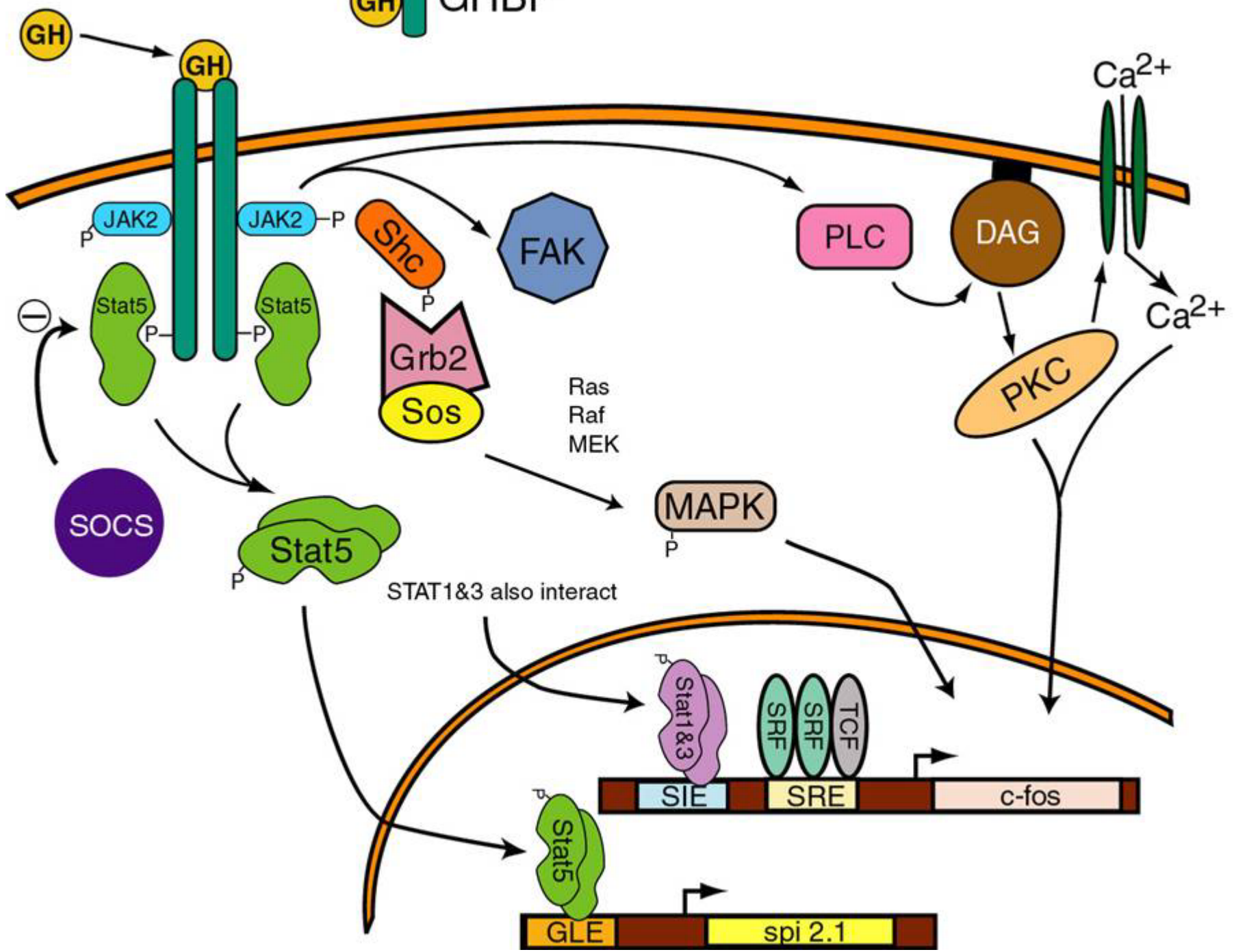

Human Growth Hormone Gene

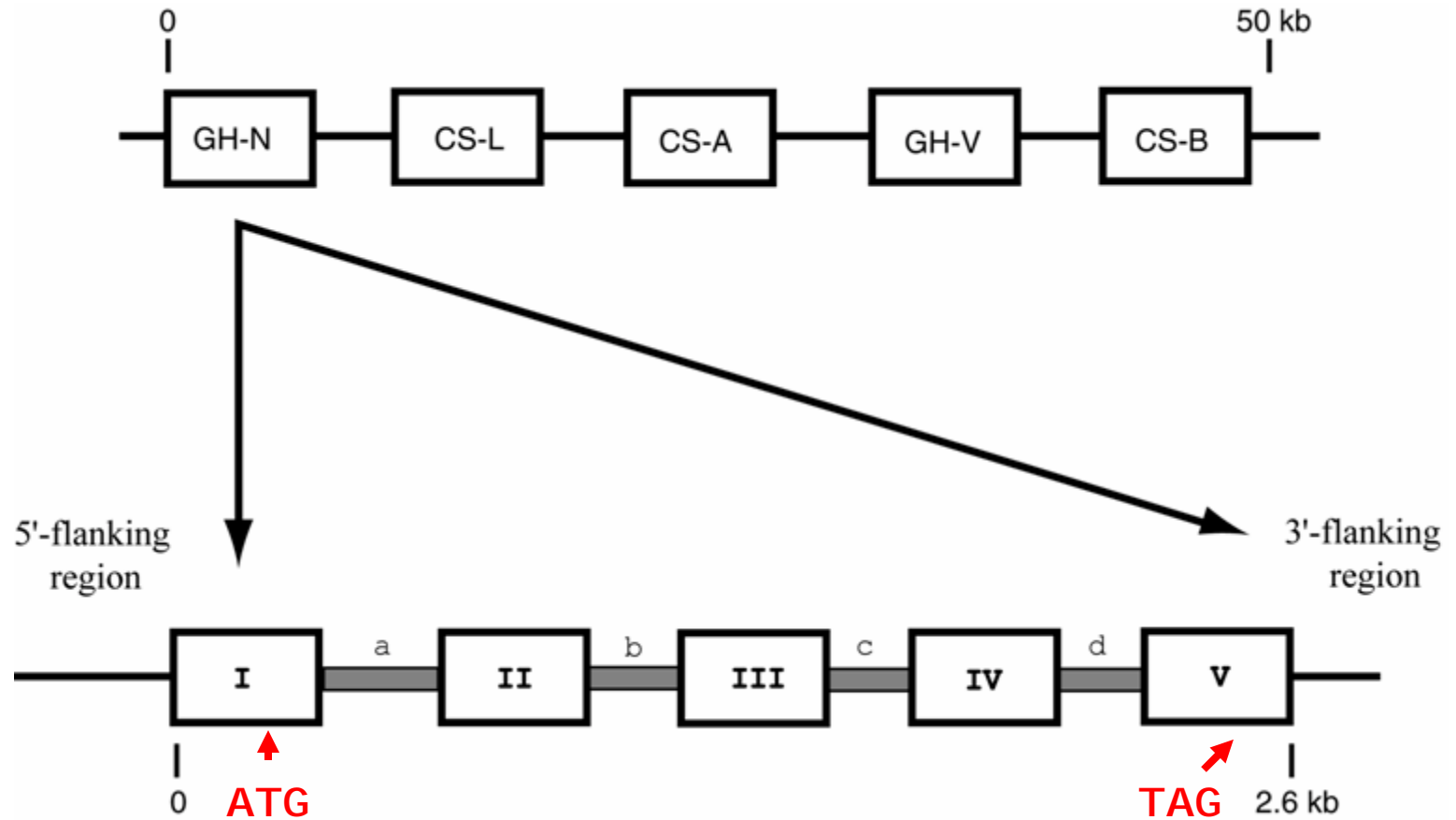

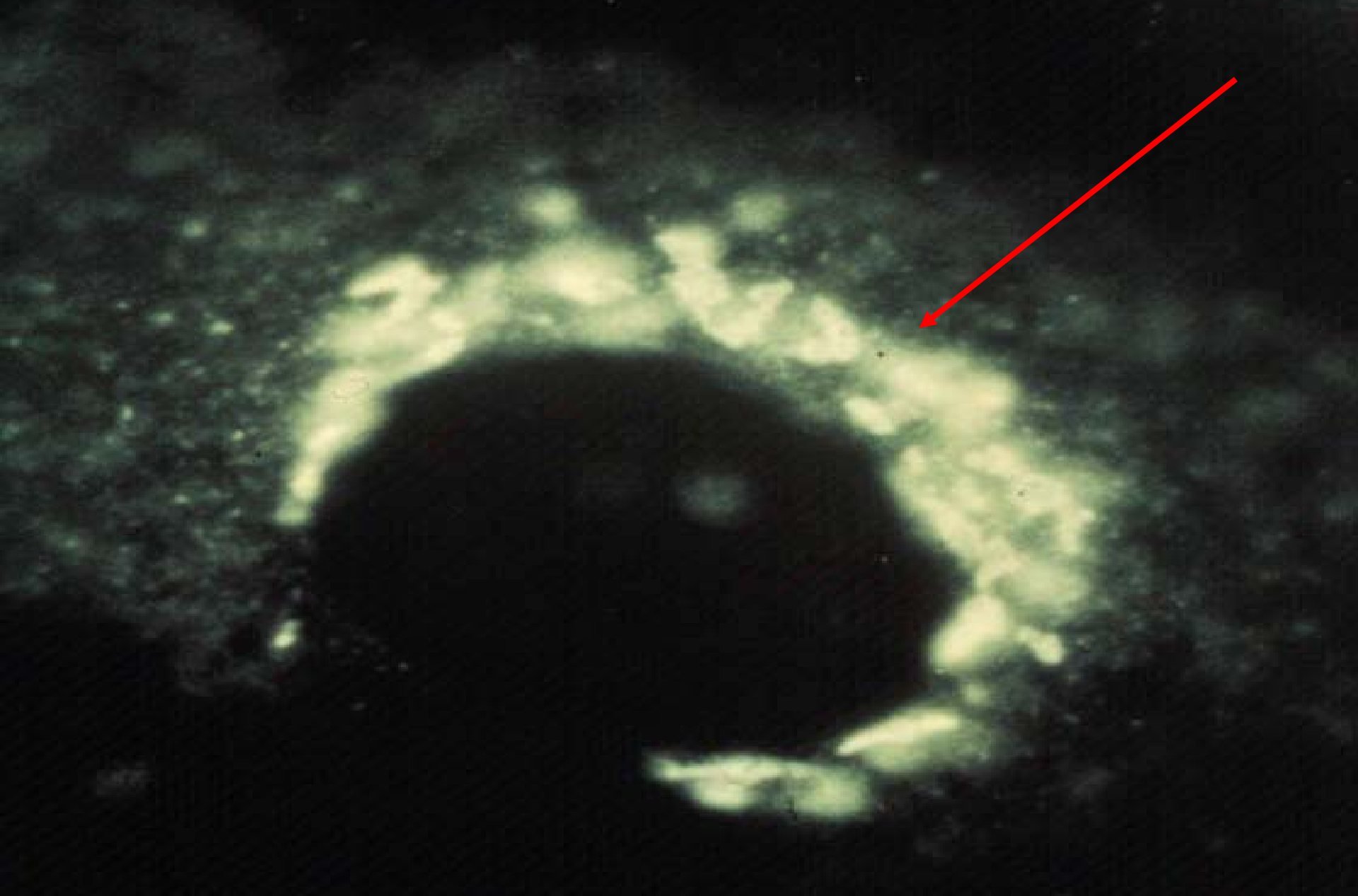

Mammalian cells expressing GH

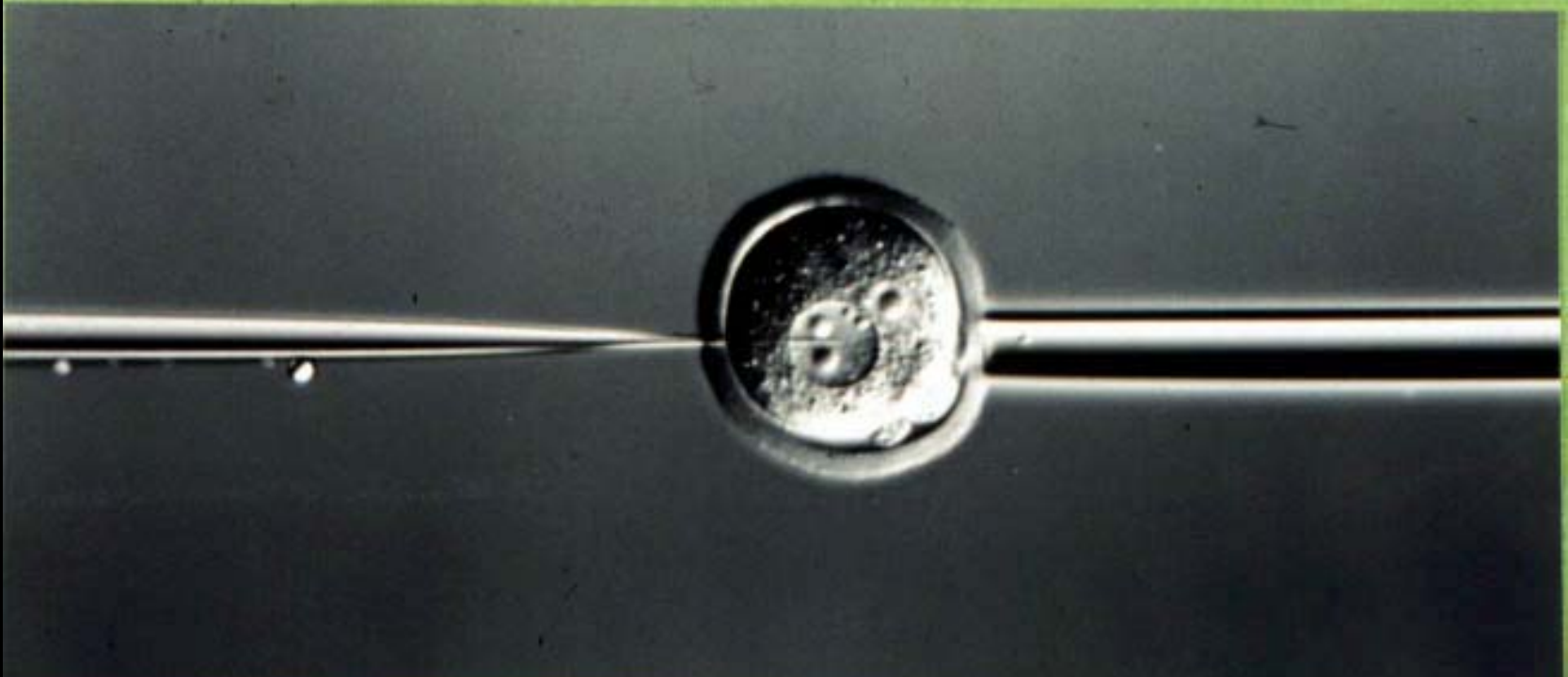
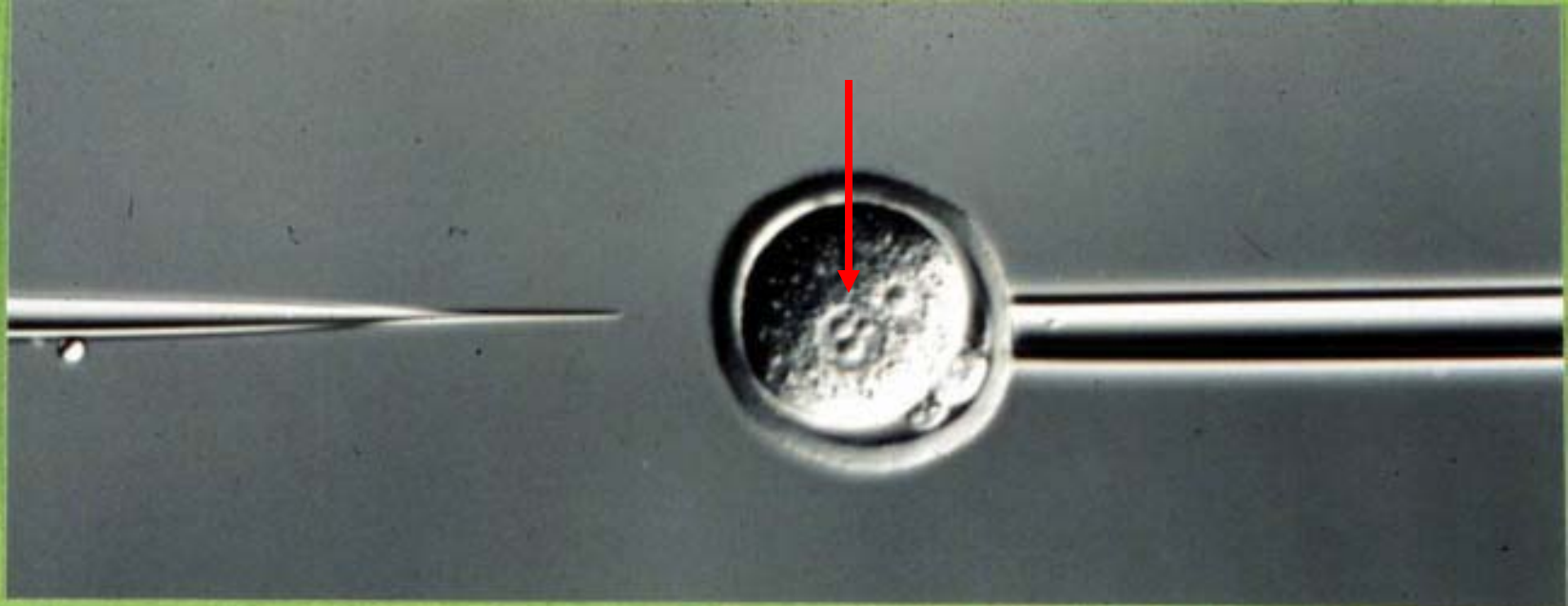

Pups are
born some
of which
are
transgenic





GH transgenic mice

GH Transgenic Mice

Control Mice



COLLIV Antiserum

Glomerulosclerosis - scarring of the glomerulus

Growth Hormone Structure/function studies

- **“Change the structure and determine the alteration in function”**

Experimental Protocols

- *In vitro* mutagenesis of GH genes or cDNAs
- Oligonucleotide sequencing of mutation
- Expression of mutated DNA in mammalian cells
- Purification of GH analogs
- Receptor Binding studies
- GH responsive cell
 - Preadipocytes or IM9
 - Engineered GHR lines

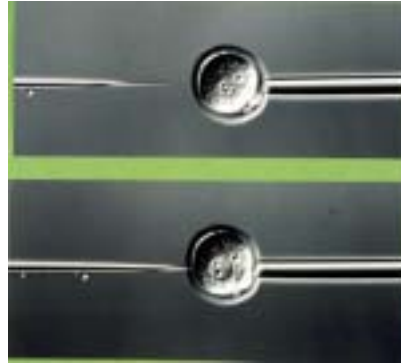

- Production of transgenic animals
- Growth parameters
 - Morphometrics
 - Endocrine and physiological studies
 - Histological studies

Animal Models

GH Crystal Structure

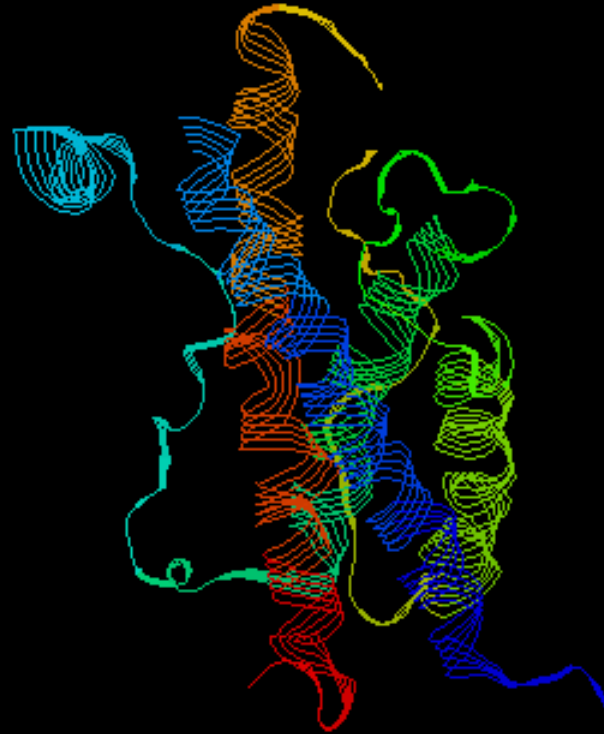

Blue = N terminus

Red = C Terminus

Light green = helix 3

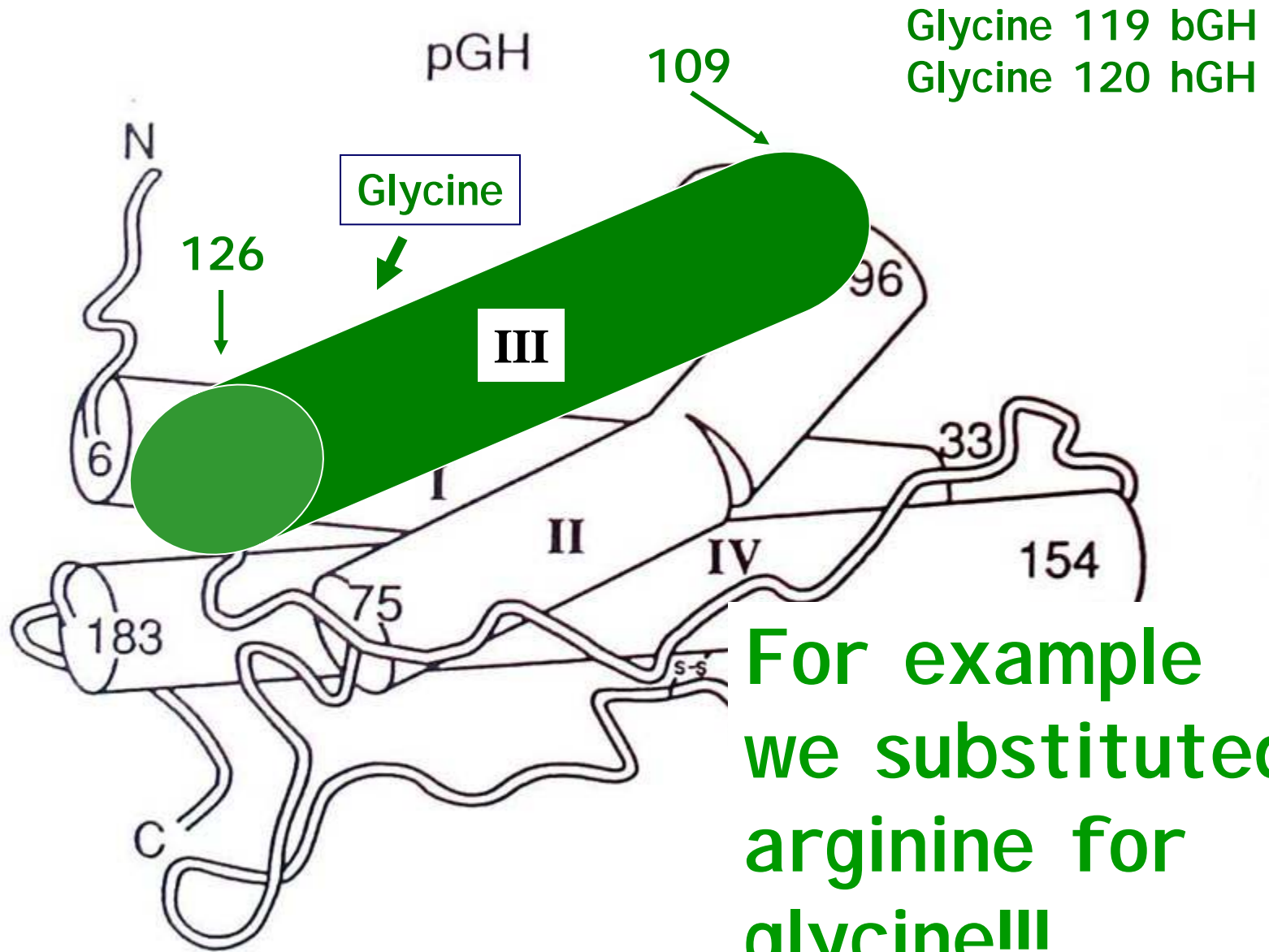

Abdel-Meguid, et al., 1987

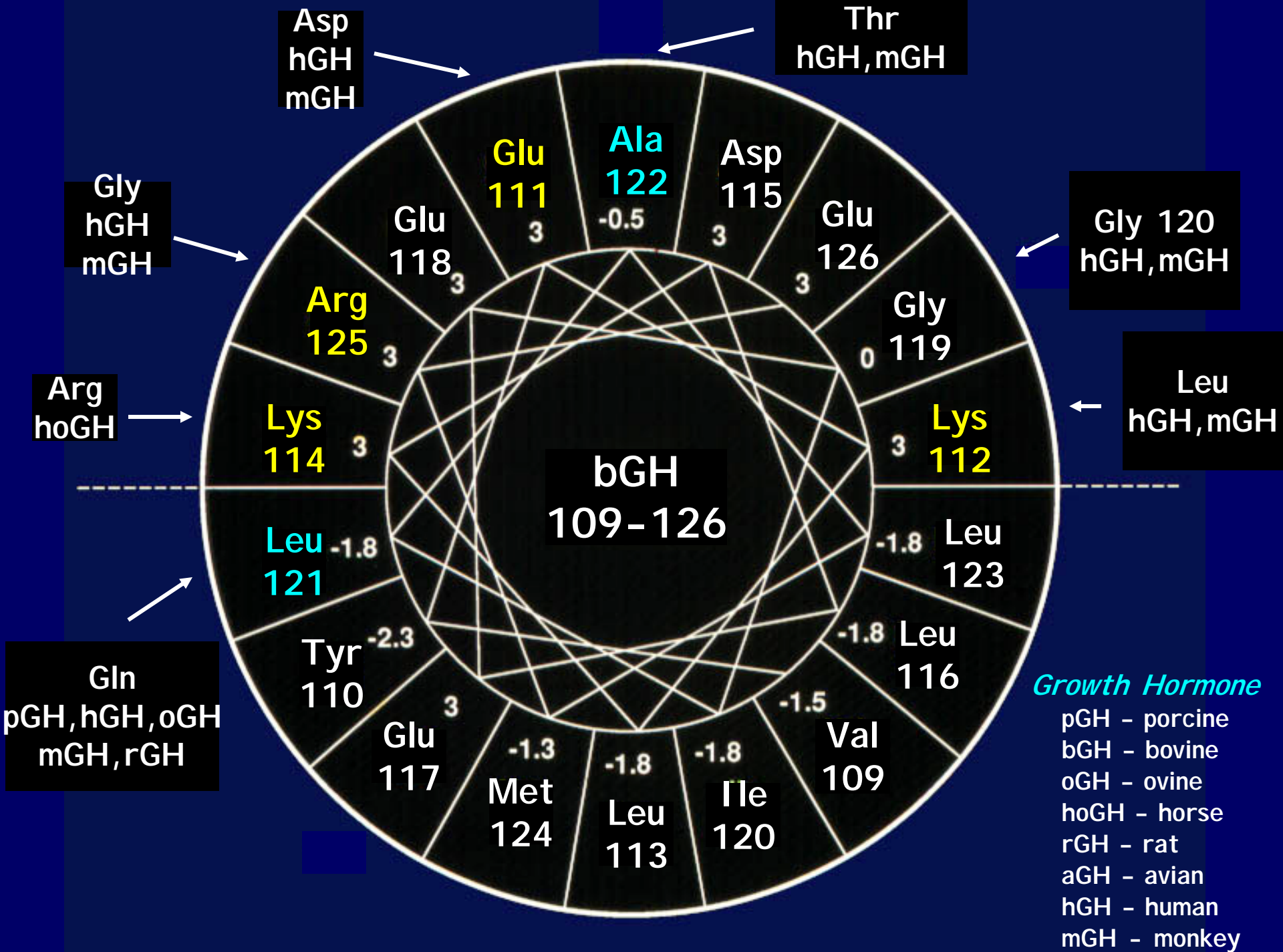



**G 120 R Transgenic Mouse
2 fold smaller than control**

Normal

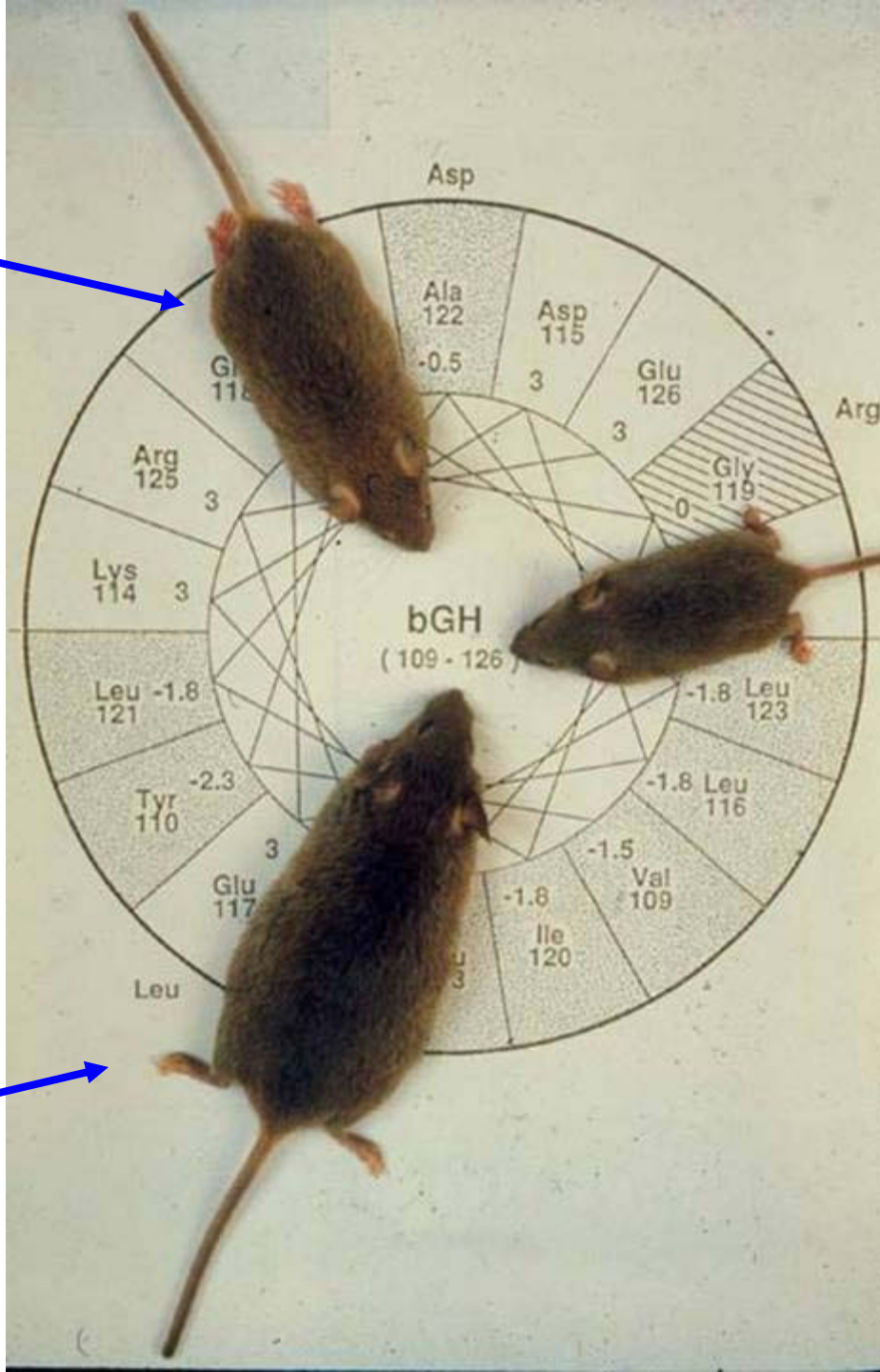

Dwarf

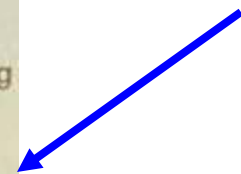

One amino acid change, i.e., glycine to arginine results in a growth inhibitor or a **“growth hormone antagonist”**

Giant



MOLECULAR ENDOCRINOLOGY

Volume 5, Number 12

December 1991

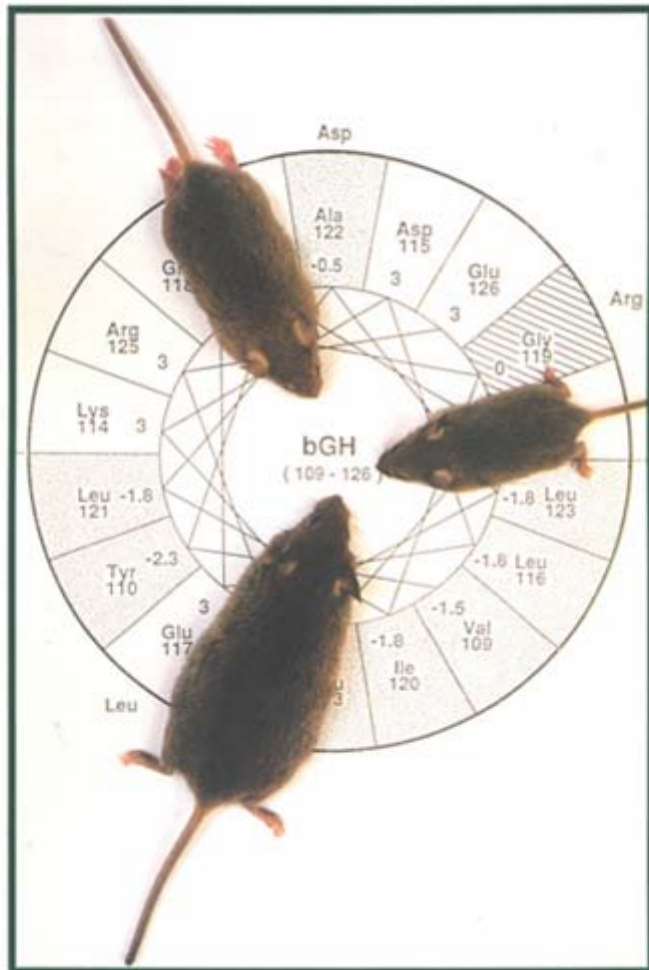

Notice Colors

Green and White

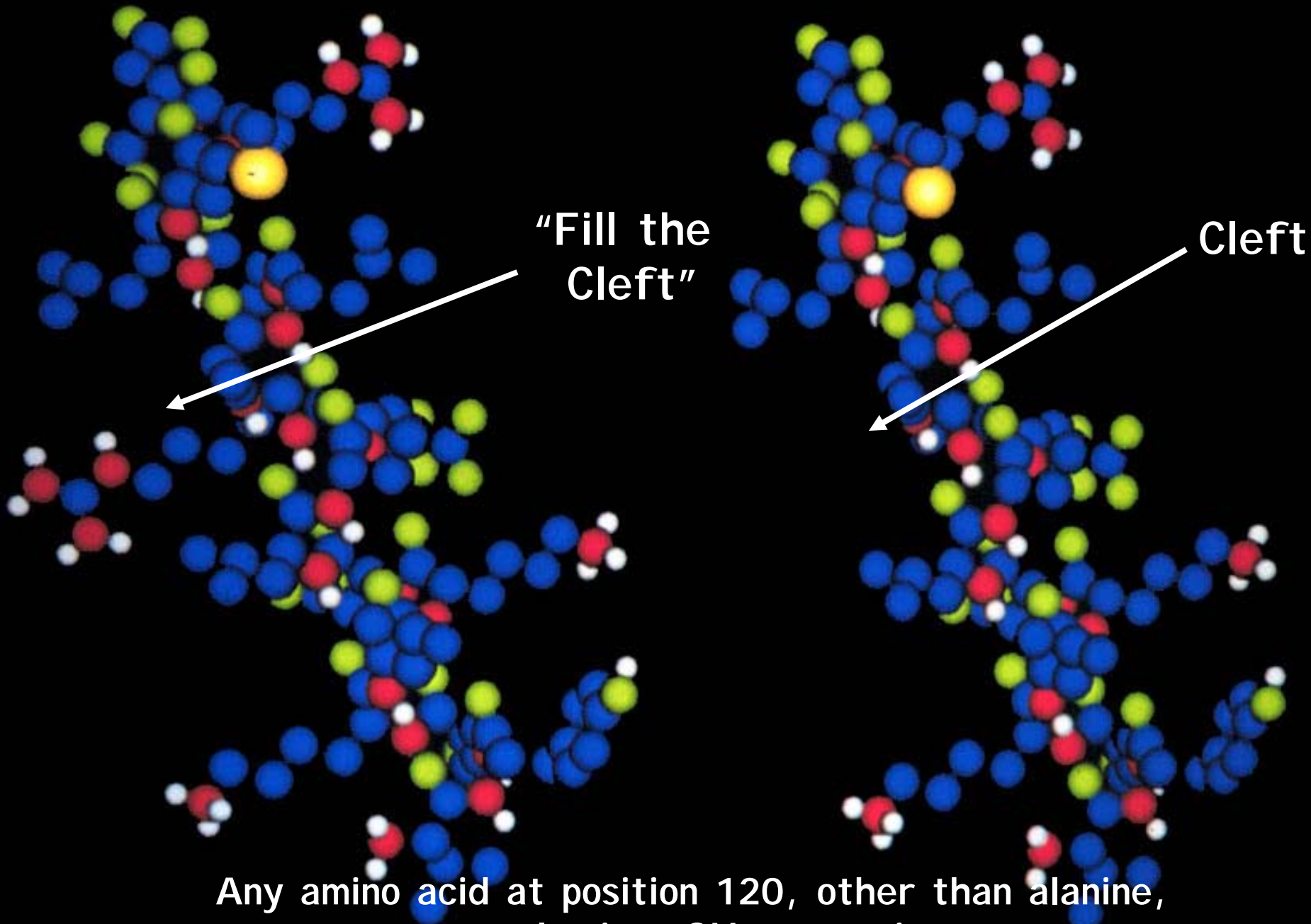

Any amino acid at position 120, other than alanine, results in a GH antagonist

GHR dimer

If the **glycine** is substituted with any amino acid, other than alanine, then a GH antagonist is generated!!

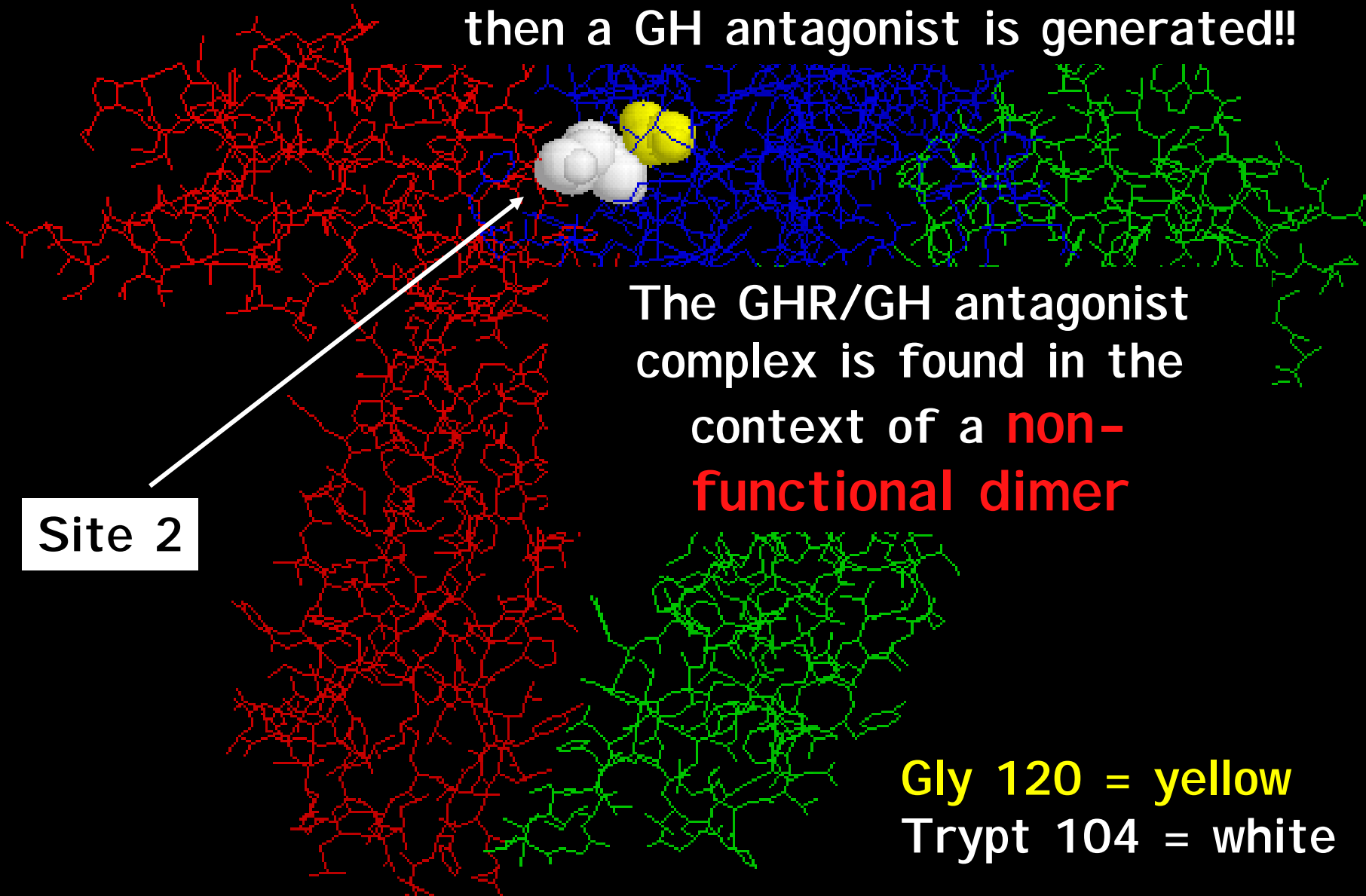

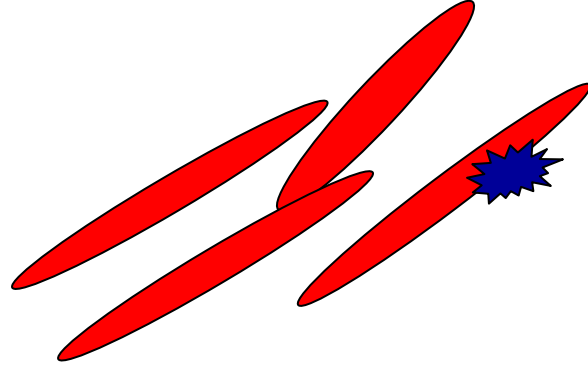

GHA

Pre-formed GHR
Dimer

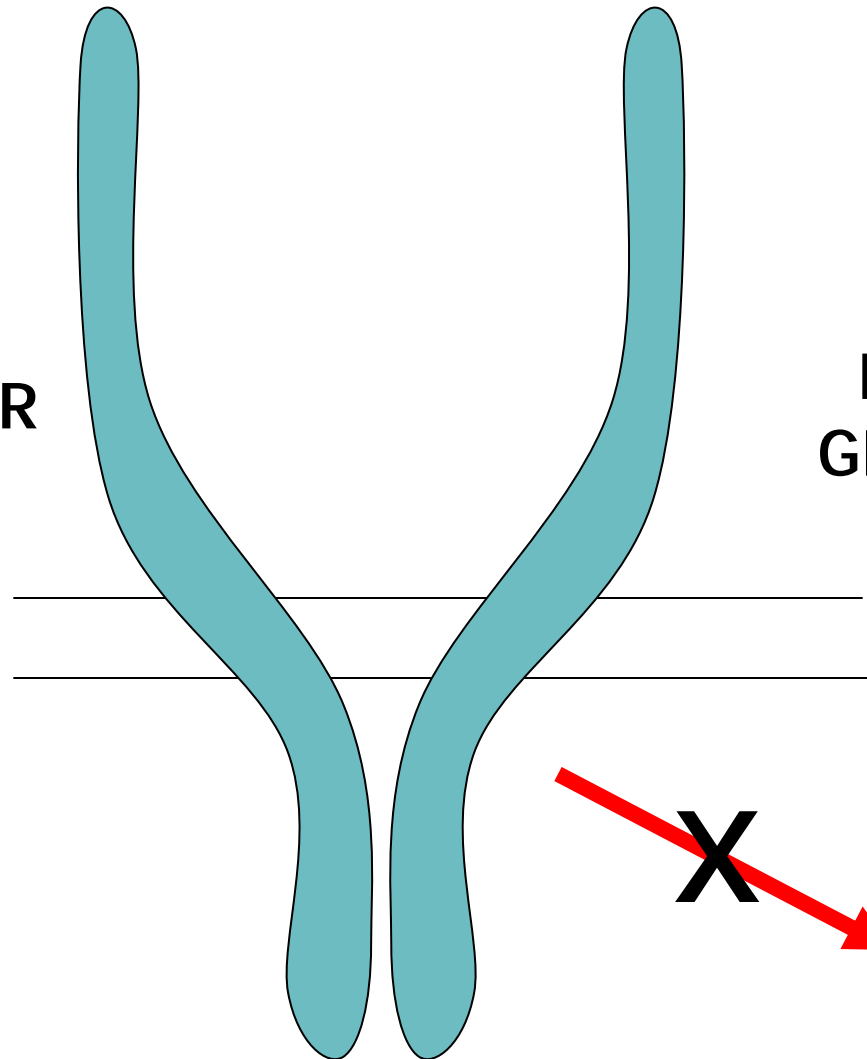

Improper or
Non-Functional
GHR Dimerization

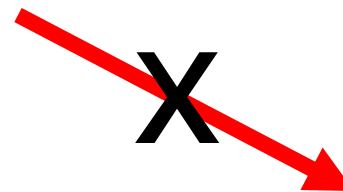

No signal
Transduction

GH/GHR interaction

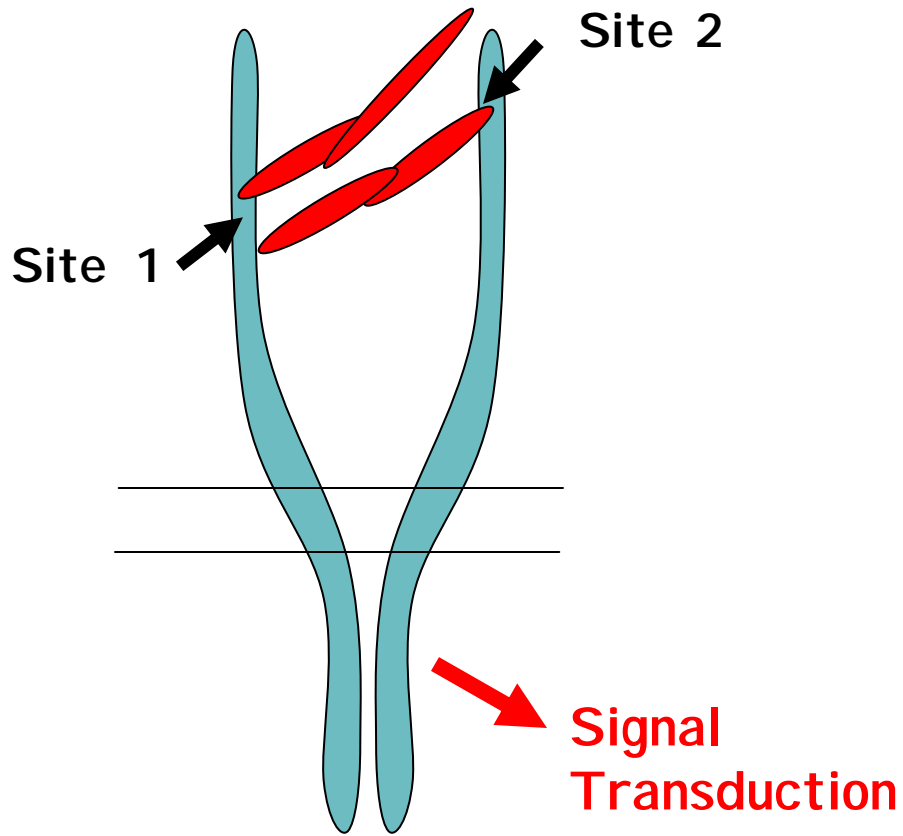

GHA/GHR interaction

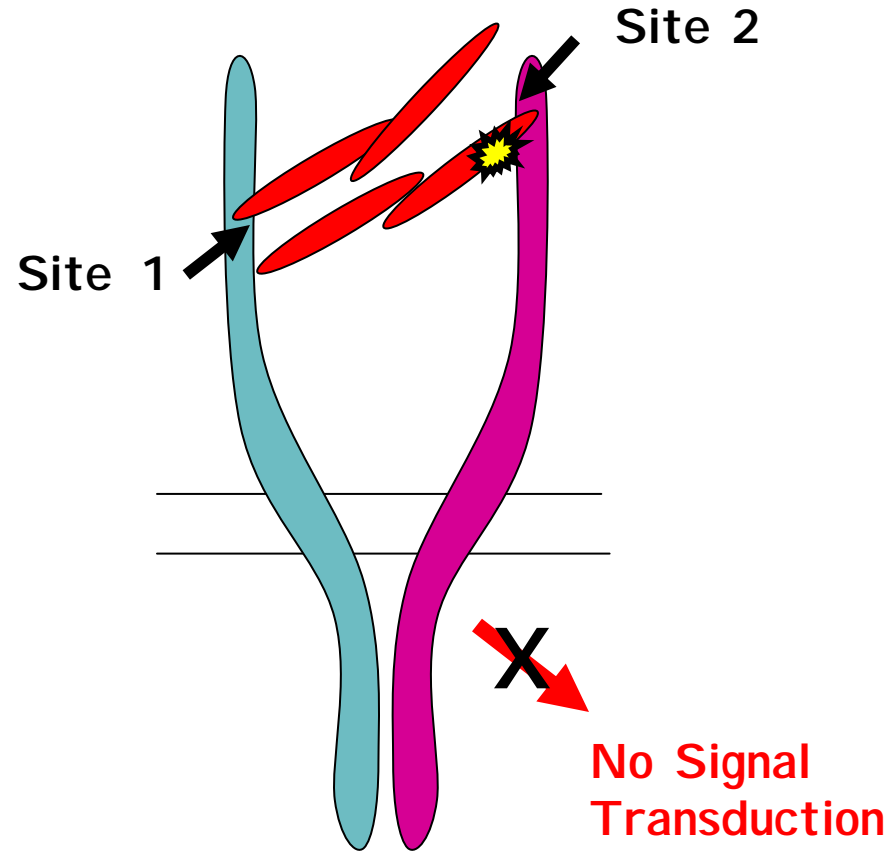

Clinical uses of a Growth Hormone Antagonist Proposed in 1991

- **Acromegaly**
- **Diabetes**
- **Cancer**

Acromegaly

Increased GH due to pituitary tumor

High circulating levels of IGF-1

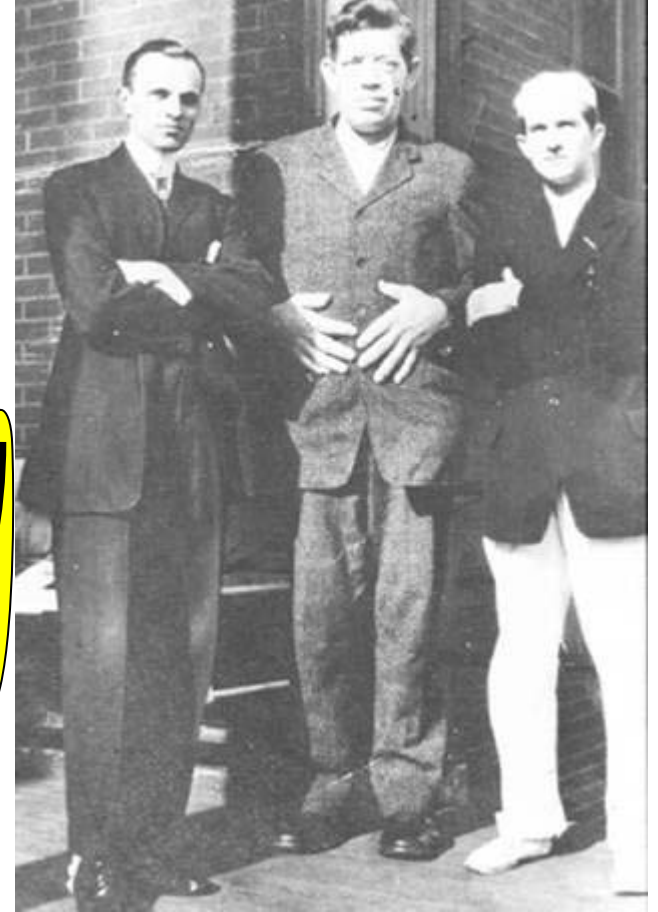
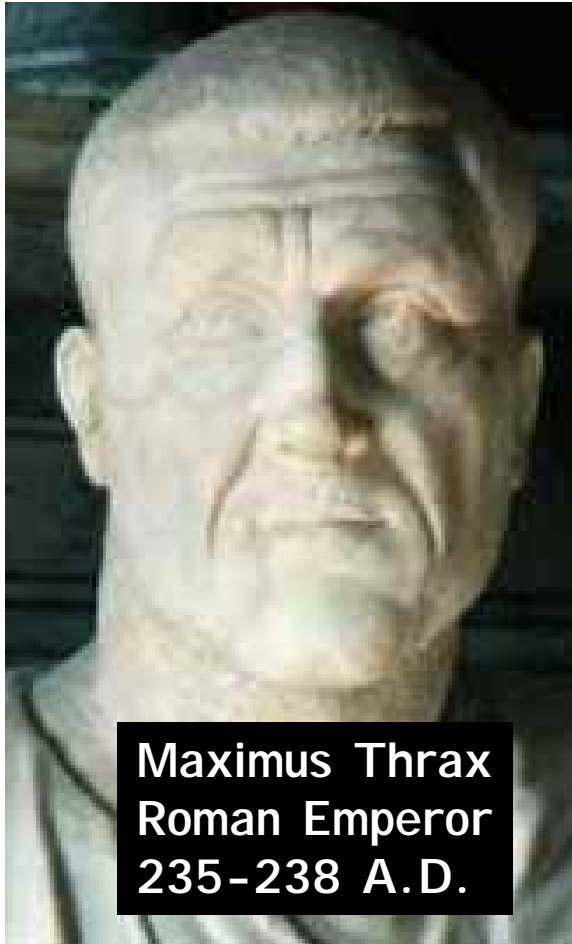

The term **acromegaly** comes from the Greek "**acros**" meaning "**extremity**" and "**megale**" meaning "**great**", for large fingers, hands and feet; distinguishing marks of this disorder.

What is a pituitary adenoma?

The pituitary gland lies behind the sphenoid bone, a bone at the base of the skull. A pituitary adenoma is a tumor of the pituitary gland. It causes symptoms either from compression of nearby brain structures or from abnormal hormone production. Most pituitary adenomas measure less than 10 mm. Almost all adenomas are benign, which means that they are relatively slow-growing and are slow to invade surrounding tissues. They rarely spread to other areas of the body.

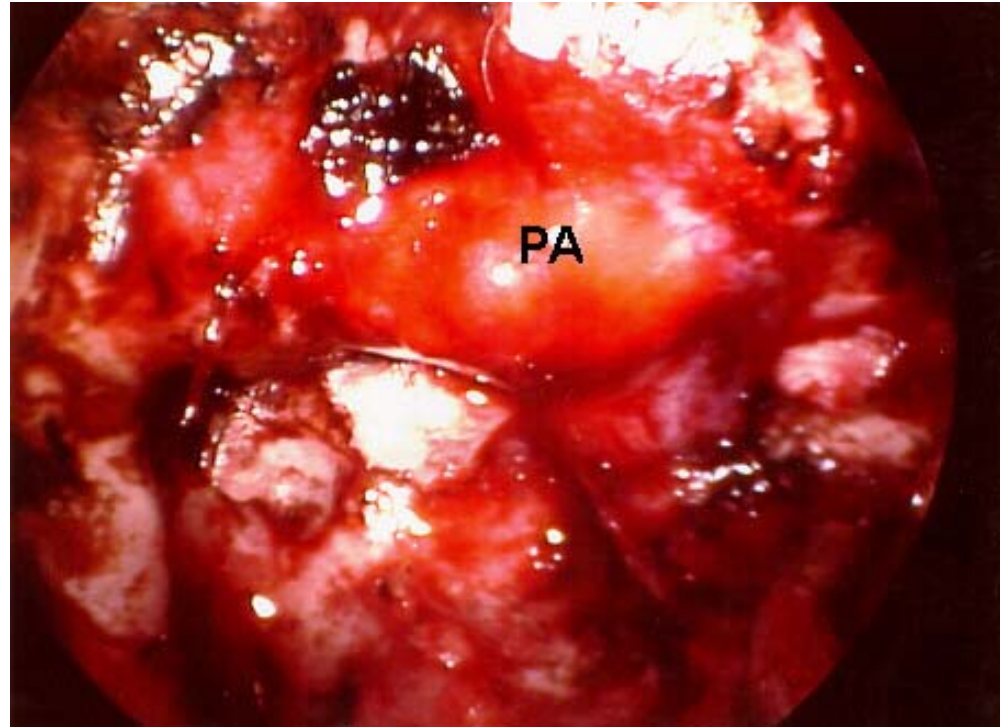

Transsphenoidal Surgery

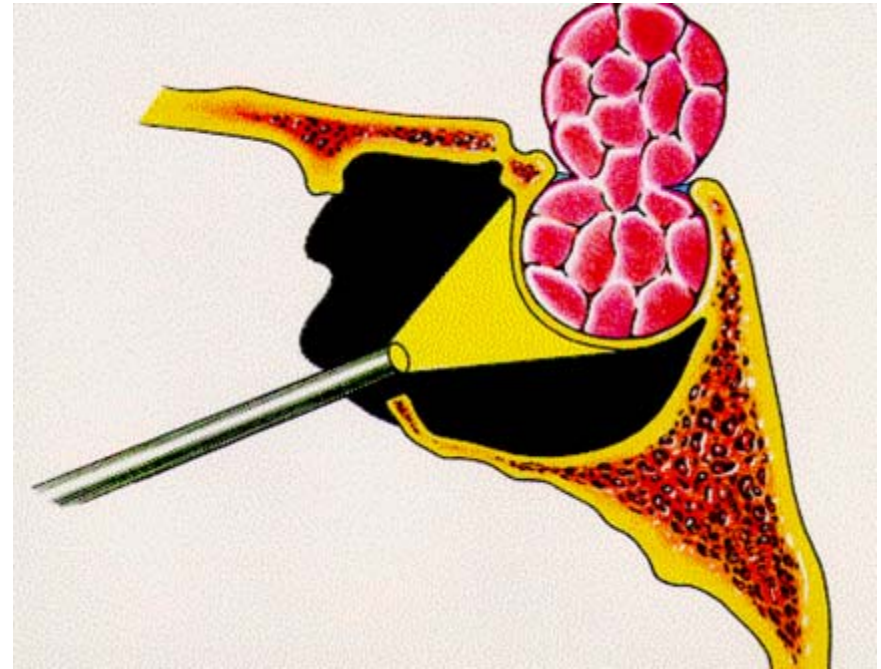
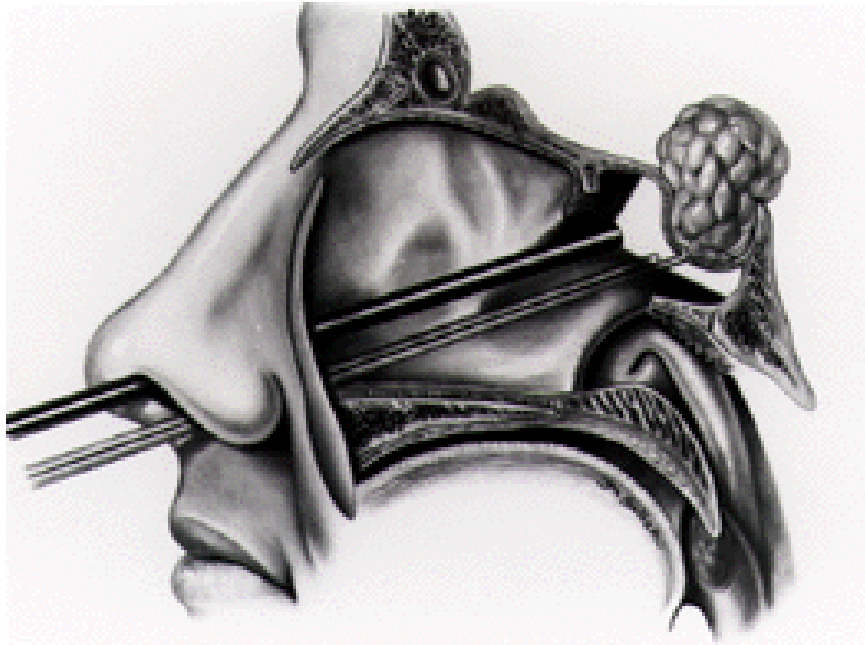

What happens during surgery?

The surgical removal of a pituitary adenoma can usually be performed by a method called a transsphenoidal operation. The surgeon approaches the pituitary gland by making an incision beneath the upper lip to expose the nasal passage. Using a microscope and specialized microinstruments, the surgeon enters the sphenoid bone, and eventually an opening is made in the wall of the bone to expose the pituitary gland. When the tumor is removed, the cavity is sealed, sometimes with a piece of fat that the surgeon removes from the patient's abdomen. The surgeon then applies a "glue" made from the patient's own blood that was donated before surgery. Vaseline gauze is then packed into the nasal cavities and the procedure is completed.

2201

19-Mar-1999

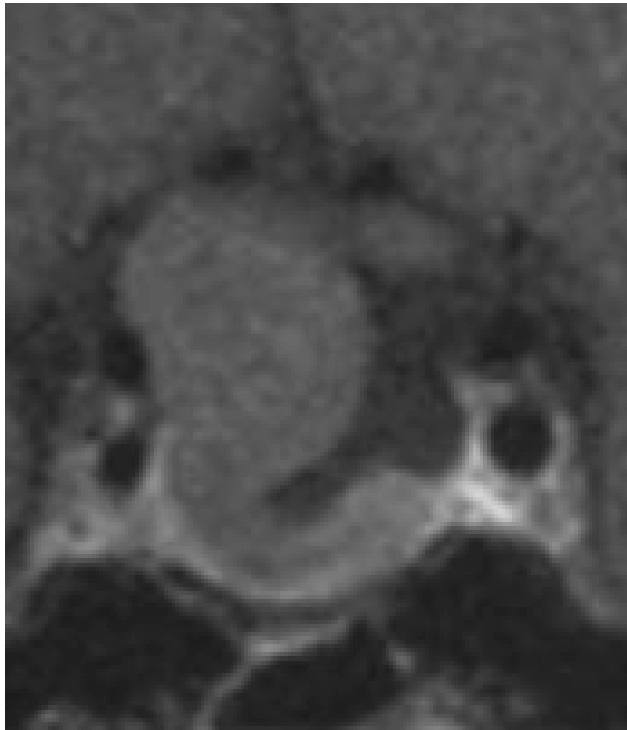

10-Mar-2000

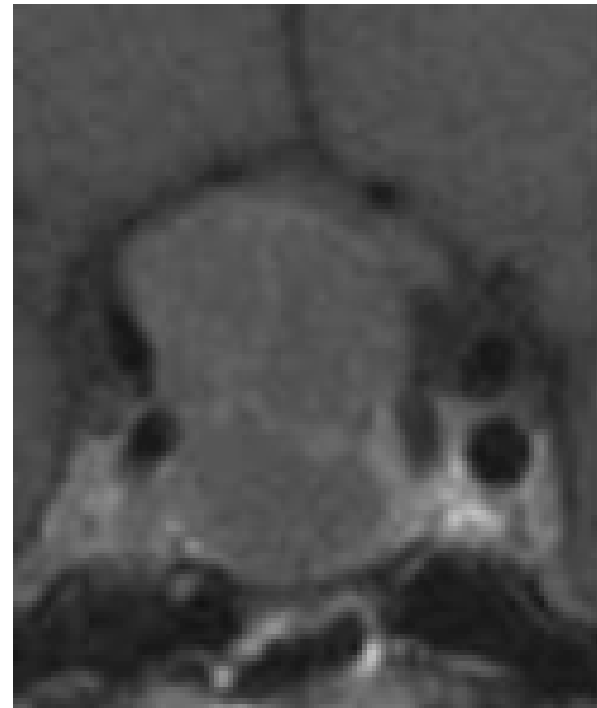

Control of GH Secretion

In Acromegalic, too much GH, therefore, too much IGF-1

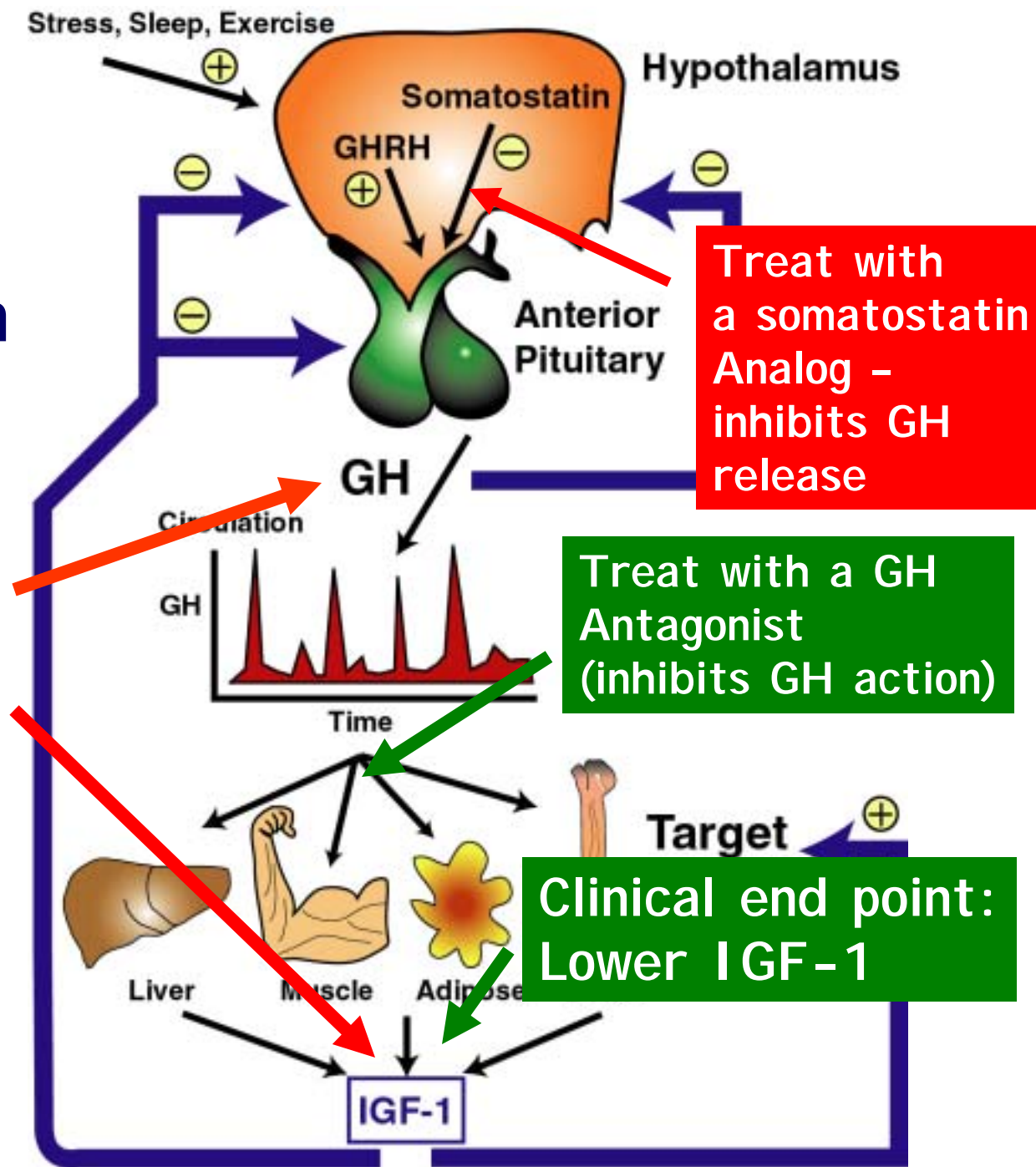

Treat with a somatostatin Analog - inhibits GH release

Treat with a GH Antagonist (inhibits GH action)

Clinical end point: Lower IGF-1

IGF-I Suppression Treatment for ≥ 12 Months (n = 90)

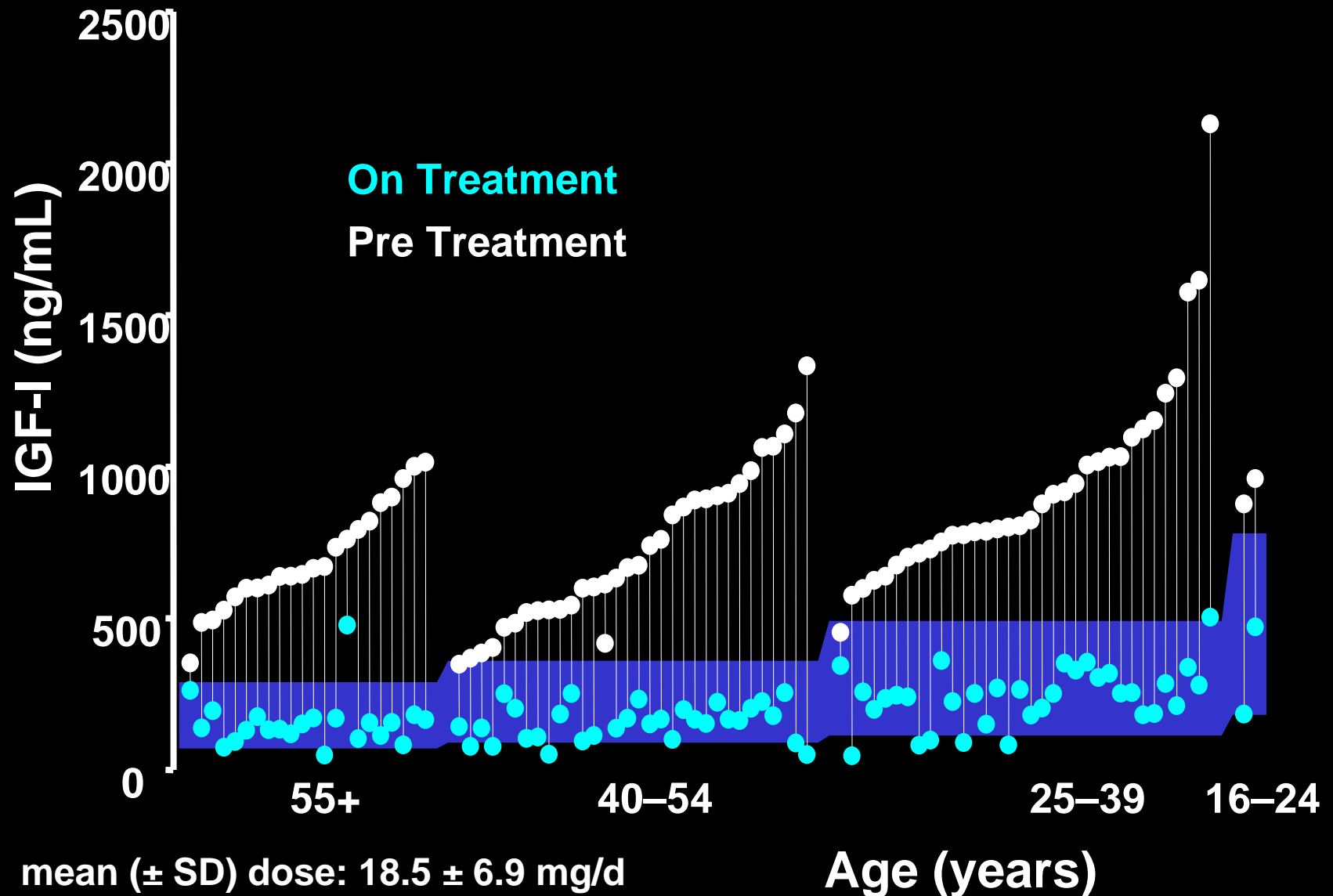

Ring size after 12 weeks of daily pegvisomant

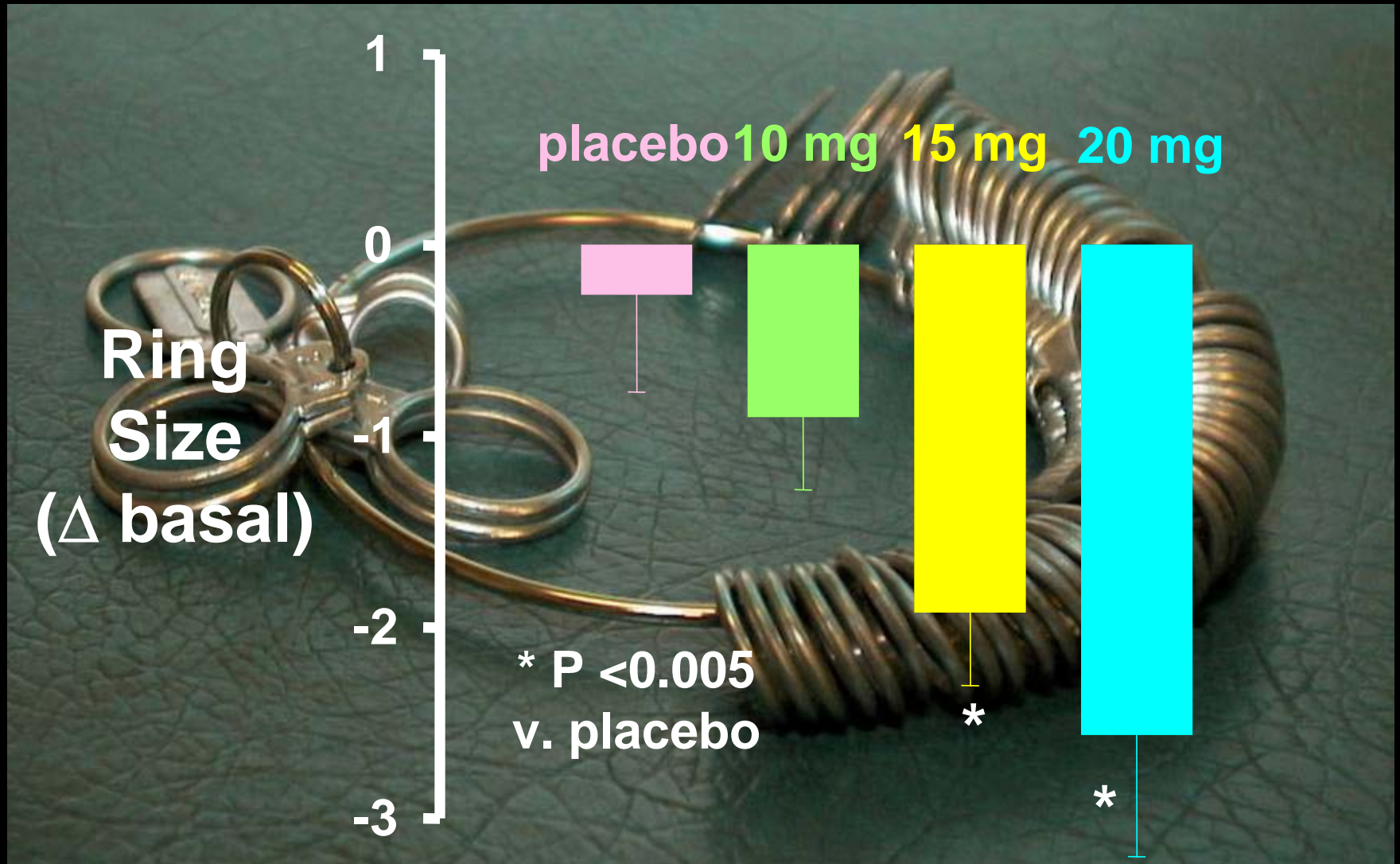

IGF-I at baseline and after 12 months of pegvisomant

- up to 40 mg/day
- 97% normalisation of IGF-I

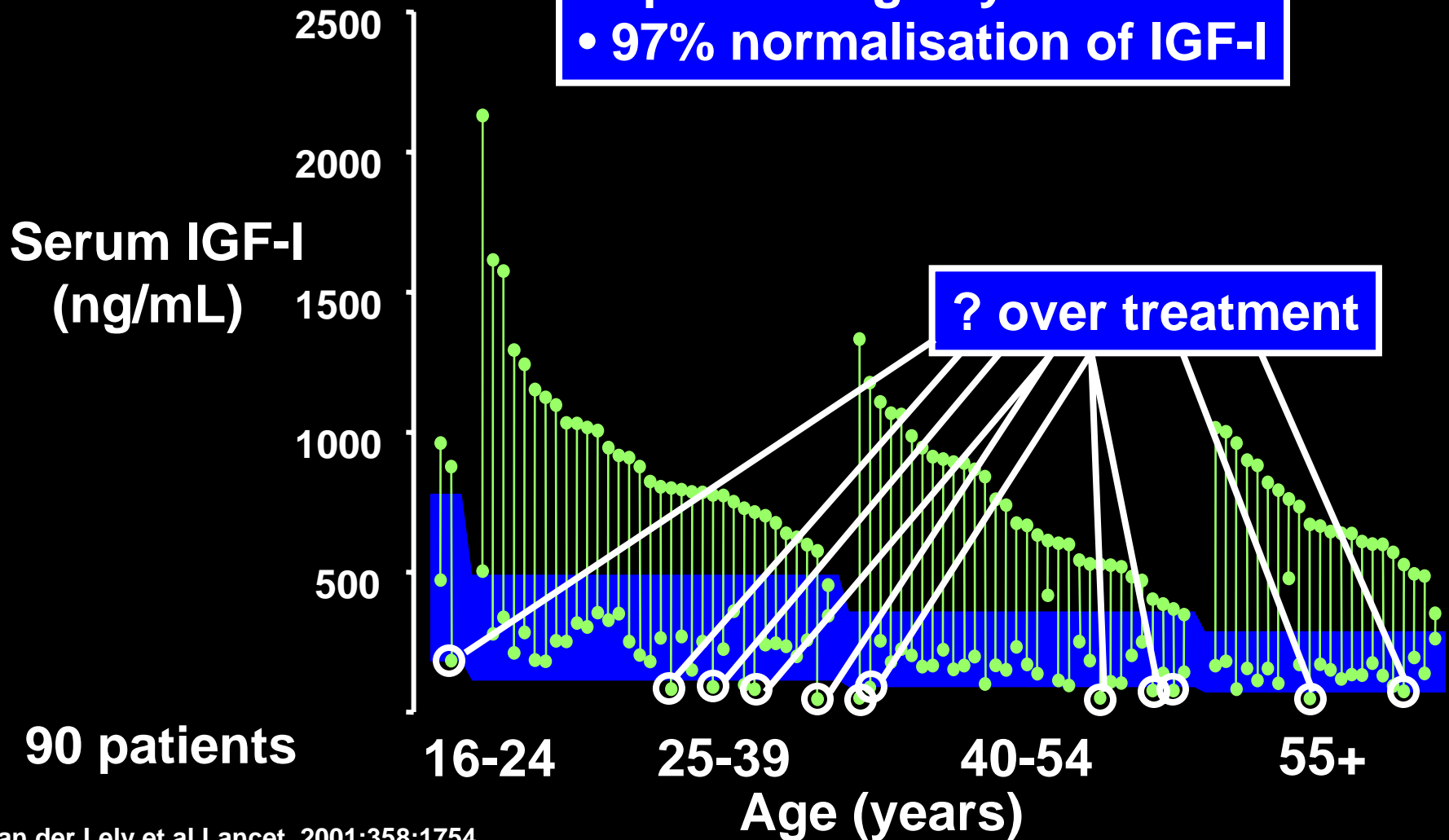

US FOOD AND DRUG ADMINISTRATION APPROVES SOMAVERT® FOR THE TREATMENT OF ACROMEGALY

The Pharmacia logo is displayed in a bold, blue, sans-serif font, positioned in the upper right corner of the page.

First in a new class of medicines treats debilitating hormone disease

Peapack, N.J. (March 26, 2003) — Pharmacia Corporation (NYSE:PHA) announced today that the US Food and Drug Administration (FDA) has approved SOMAVERT® (pegvisomant for injection) for the treatment of acromegaly in patients who have had an inadequate response to surgery and/or radiation therapy and/or other medical therapies, or for whom these therapies are not appropriate. The goal of treatment is to normalize serum IGF-I levels.

Acromegaly is a serious, life-shortening disease triggered by over-secretion of growth hormone, most often caused by a pituitary tumor. This excess of growth hormone leads to overproduction of a second hormone, IGF-I (insulin-like growth factor-I), which contributes to the disabling symptoms and the long-term health problems associated with the disorder.^[i] Patients with acromegaly often suffer from headache, excessive sweating, soft-tissue swelling, joint disorders and, perhaps most striking, a progressive coarsening of facial features and enlargement of the hands, feet and jaw.^[ii] Patients with acromegaly face a mortality rate two to four times higher than the average person, due to such serious long-term complications as heart and respiratory disease, diabetes mellitus and some forms of cancer.

SOMAVERT is the first in a new class of medicines called growth hormone receptor antagonists and the only medicine designed to specifically block the effects of excess growth hormone in acromegaly. It will be available in the US by prescription within the next few weeks. SOMAVERT was approved by the European Commission in November 2002.^[i]

“SOMAVERT is an important medical advance that offers new hope to patients with acromegaly,” said Ariel Barkan, MD, Professor of Internal Medicine, Professor of Neurosurgery and Co-director of the Pituitary and Neuroendocrine Center, University of Michigan Health Systems, and clinical investigator for SOMAVERT. “We are very encouraged by the introduction of SOMAVERT, an important new treatment option for those who are suffering the ravages of this disease,” said Robert Knutzen, acromegaly patient and CEO/Chairman of the Pituitary Network Association, an international non-profit organization dedicated to providing support and information to patients with pituitary disorders.^[iii]

SOMAVERT® (pegvisomant for injection)

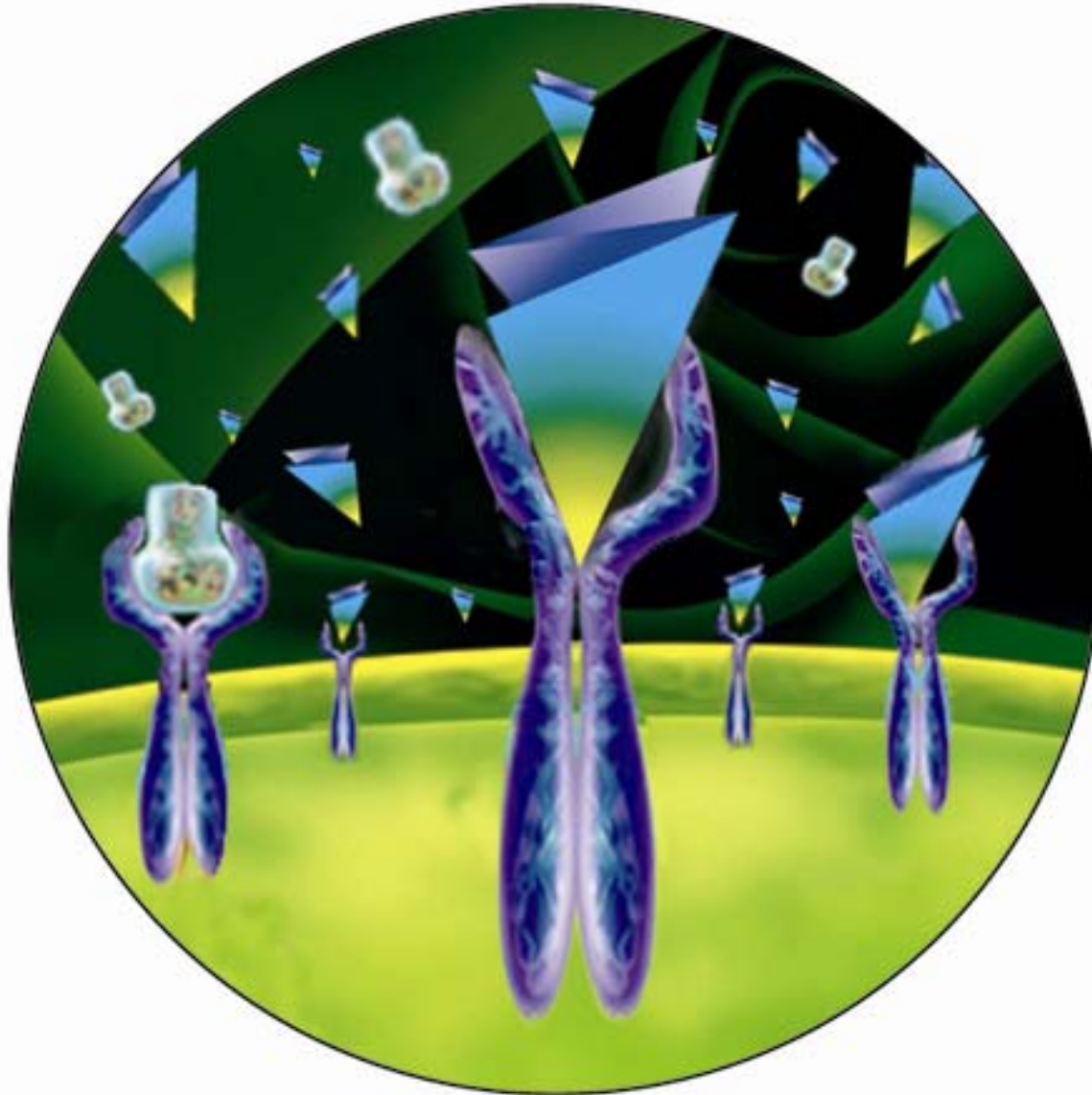

Clinical uses of Growth Hormone Antagonists

- Acromegaly
- Diabetes
- Cancer

GH antagonist and cancer

- **GH/IGF-1 implicated in many cancers including breast, colon and prostate**

K. Friend and M. Pollack have pioneered this type of work

A Growth Hormone Antagonist Confers Resistance to DMBA-Induced Mammary Gland Carcinogenesis

Michael Pollak¹, Marie-José Blouin, Jian-Chun Zhang, and John J. Kopchick

Cancer Prevention Research Unit of the Jewish General Hospital and McGill University, Montreal, Quebec, Canada, H3T 1E2 (MP, MJB, JCZ),
Edison Biotechnology Institute and Department of Biomedical Sciences, College of Osteopathic Medicine, Ohio University, Athens, Ohio, 45701,
USA (JJK)

Br J Cancer, 2001

- ✦ Used GH antagonist transgenic mice and controls
- ✦ 28 female animals
- ✦ DMBA injected by gavage (70ug/g body weight) once a week for 6 weeks
- ✦ Mice monitored weekly for tumor incidence and size of tumor



Control



GHA

Tumor incidence: GH antagonist tg vs. control following DMBA exposure

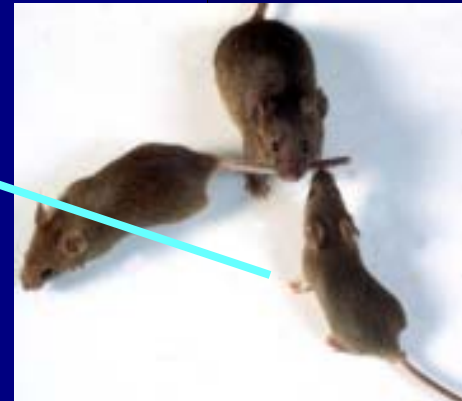
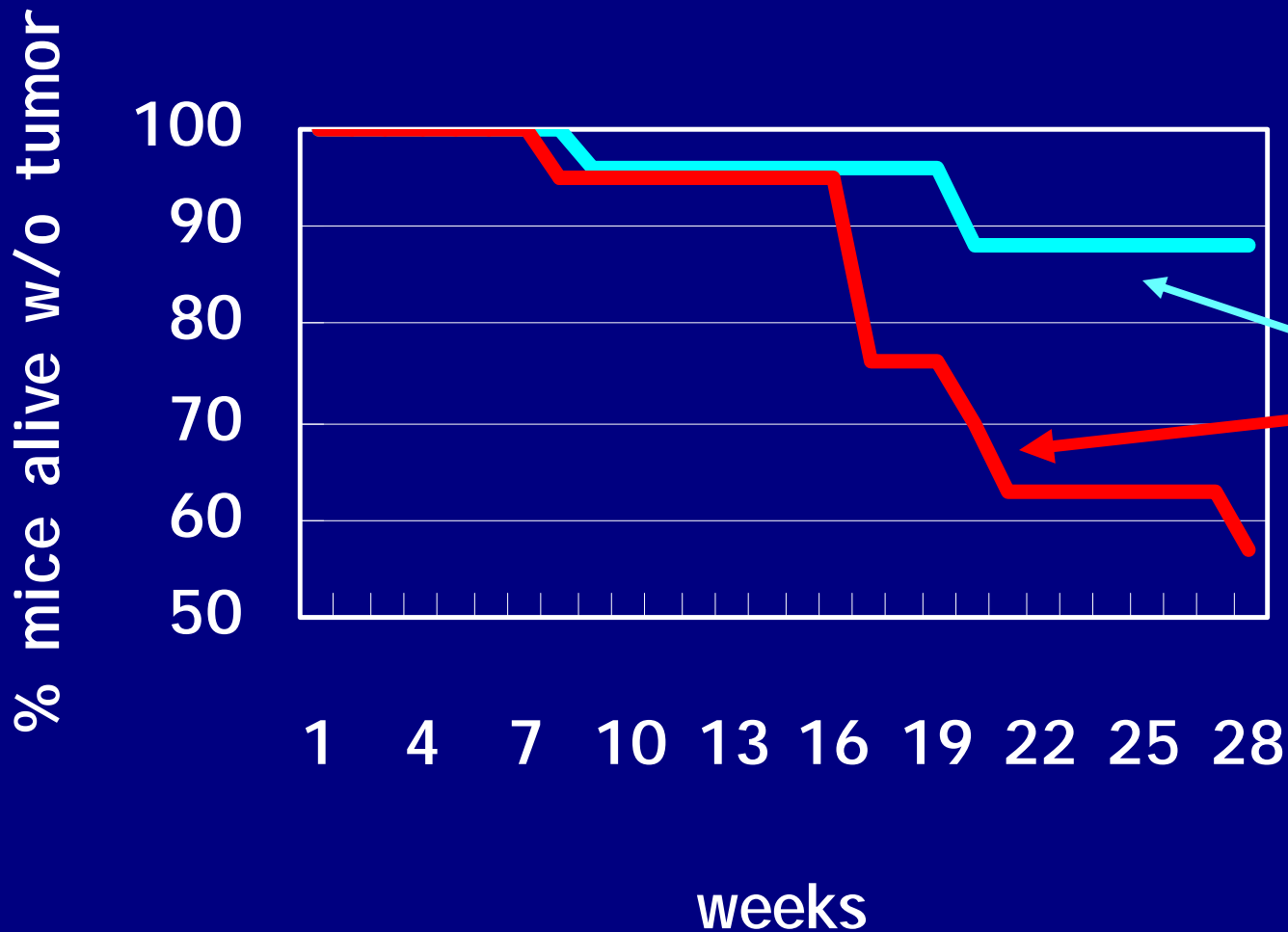

Reading List

- **Endocrinology**, Fourth Edition, edited by *Leslie DeGroot and J. Larry Jameson*, Volume 1, Part III (Growth and Maturation), Chapters 30-38, pages 389-529
- **REVIEW ARTICLE PEDIATRICS Vol. 112 No. 1 July 2003, pp. 150-162**

Persistent Short Stature, Other Potential Outcomes, and the Effect of Growth Hormone Treatment in Children Who Are Born Small for Gestational Age

Peter A. Lee, MD, PhD, James W. Kendig, MD and James R. Kerrigan, MD From the Department of Pediatrics, Pennsylvania State University College of Medicine, Milton S. Hershey Medical Center, Hershey, Pennsylvania